

# MC919Z RFID Mobile Computer Integrator Guide Supplement

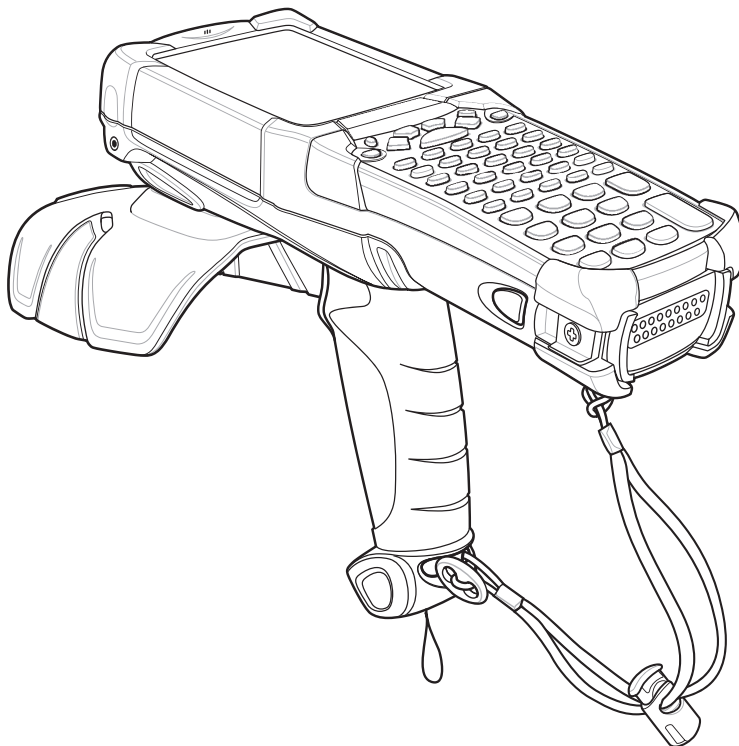



# ***MC919Z Integrator Guide Supplement***

*72E-157455-02*

*Rev A*

*March 2015*

© 2015 Symbol Technologies, Inc.

No part of this publication may be reproduced or used in any form, or by any electrical or mechanical means, without permission in writing from Zebra. This includes electronic or mechanical means, such as photocopying, recording, or information storage and retrieval systems. The material in this manual is subject to change without notice.

The software is provided strictly on an “as is” basis. All software, including firmware, furnished to the user is on a licensed basis. Zebra grants to the user a non-transferable and non-exclusive license to use each software or firmware program delivered hereunder (licensed program). Except as noted below, such license may not be assigned, sublicensed, or otherwise transferred by the user without prior written consent of Zebra. No right to copy a licensed program in whole or in part is granted, except as permitted under copyright law. The user shall not modify, merge, or incorporate any form or portion of a licensed program with other program material, create a derivative work from a licensed program, or use a licensed program in a network without written permission from Zebra. The user agrees to maintain Zebra’s copyright notice on the licensed programs delivered hereunder, and to include the same on any authorized copies it makes, in whole or in part. The user agrees not to decompile, disassemble, decode, or reverse engineer any licensed program delivered to the user or any portion thereof.

Zebra reserves the right to make changes to any software or product to improve reliability, function, or design.

Zebra does not assume any product liability arising out of, or in connection with, the application or use of any product, circuit, or application described herein.

No license is granted, either expressly or by implication, estoppel, or otherwise under any Zebra Technologies Corporation., intellectual property rights. An implied license only exists for equipment, circuits, and subsystems contained in Zebra products.

Zebra and the Zebra head graphic are registered trademarks of ZIH Corp. The Symbol logo is a registered trademark of Symbol Technologies, Inc., a Zebra Technologies company.

Zebra Technologies Corporation  
Lincolnshire, IL U.S.A.  
<http://www.zebra.com>

---

## Revision History

Changes to the original manual are listed below:

Change	Date	Description
Rev A	02/2012	Initial release.
Rev A	3/2015	Zebra Rebranding



# Table of Contents

Revision History .....	iii
------------------------	-----

## Table of Contents

### About This Guide

Introduction .....	ix
Configurations .....	ix
Chapter Descriptions .....	x
Notational Conventions .....	x
Related Documents and Software .....	xi
Service Information .....	xi

### Chapter 1: Getting Started

Introduction .....	1-1
RFID Technology Overview .....	1-1
RFID Components .....	1-2
MC919Z RFID Mobile Computer .....	1-3
MC919Z Parts .....	1-4
MC919Z LED Indicators .....	1-5
Reading Tags .....	1-5

### Chapter 2: Updating the RFID Mobile Computer

Introduction .....	2-1
Updating the Device Image .....	2-1
Downloading an Update Loader Package .....	2-1
Updating Images via ActiveSync .....	2-1
Updating the RFID Firmware .....	2-2

**Chapter 3: MobileRFID Functionality**

Introduction .....	3-1
MobileRFID Icons .....	3-2
MobileRFID Menu .....	3-3
Configure Region .....	3-4
Configure RFID .....	3-7
Version Information .....	3-8
Run/Stop RFID .....	3-9

**Chapter 4: RFID Sample Application**

Introduction .....	4-1
Launching the RFID Sample Application .....	4-2
Connection .....	4-3
Capabilities .....	4-4
Configuration Menu Options .....	4-5
Tag Storage Settings .....	4-5
Antenna .....	4-6
RF Mode .....	4-7
Singulation .....	4-8
Power On/Off Radio .....	4-9
Reset to Factory Default .....	4-9
Operations Menu Options .....	4-10
Antenna Info .....	4-10
Filter .....	4-11
Access .....	4-14
Triggers .....	4-19
Management Menu Options .....	4-26
Help Menu .....	4-26
Exit .....	4-26

**Chapter 5: Tag Locator**

Introduction .....	5-1
Using Tag Locator .....	5-2
Locating Tags Using a .csv File .....	5-3

**Chapter 6: Troubleshooting**

Introduction .....	6-1
Troubleshooting .....	6-1
MC919Z .....	6-1
Bluetooth Connection .....	6-3
Four Slot Charge Only Cradle .....	6-4
Four Slot Ethernet Cradle .....	6-4
Four Slot Spare Battery Charger .....	6-6
Single Slot Serial/USB Cradle .....	6-6
Cable Adapter Module .....	6-7
Magnetic Stripe Reader .....	6-8
Modem Module .....	6-9



**Appendix A: Technical Specifications**

MC919Z Specifications .....	A-1
Decode Zones .....	A-5
SE960 Standard Range Laser Decode Zones .....	A-5
SE1524 Long Range Laser Decode Zones .....	A-7
SE4500 Standard Range Imager Decode Zones .....	A-9
Mobile Computer Pin-Outs .....	A-13
Accessory Specifications .....	A-14
Single Slot Serial/USB Cradle .....	A-14
Four Slot Ethernet Cradle .....	A-14
Four Slot Charge Only Cradle .....	A-15
Four Slot Battery Charger .....	A-15
Magnetic Stripe Reader .....	A-16
Accessory CAM and MSR Pin-Outs .....	A-17

**Appendix B: RFID APIs****Index**



# About This Guide

---

## Introduction

This MC919Z RFID Integrator Guide Supplement provides the unique set up and operating procedures for the MC919Z RFID mobile computers. This guide is intended as a supplement to the *MC9190-G Integrator Guide*, p/n 72E-140937-xx. Procedures common to MC9100 products are addressed in the *MC9190-G Integrator Guide*.

✓ **NOTE** Screens and windows pictured in this guide are samples and can differ from actual screens.

---

## Configurations

This guide covers the following configurations:

Configuration	RFID Frequency Band Support	Description
MC919Z-GA0SWEQZ1WR	US	RFID, 1D, CLR, 256/1G, 53, WM6.5
MC919Z-GA0SWEQZ2EU	EU	RFID, 1D, CLR, 256/1G, 53, WM6.5
MC919Z-G30SWEQZ1WR	US	RFID, 2D, CLR, 256/1G, 53, WM6.5
MC919Z-G30SWEQZ2EU	EU	RFID, 2D, CLR, 256/1G, 53, WM6.5
MC919Z-G50SWEQZ1WR	US	RFID, DPM, 2D, CLR, 256/1G, 53, WM6.5
MC919Z-G50SWEQZ2EU	EU	RFID, DPM, 2D, CLR, 256/1G, 53, WM6.5
MC919Z-GJ0SWEQZ1WR	US	RFID, LRX, CLR, 256/1G, 53, WM6.5
MC919Z-GJ0SWEQZ2EU	EU	RFID, LRX, CLR, 256/1G, 53, WM6.5

---

## Chapter Descriptions

Topics covered in this guide are as follows:

- *Chapter 1, Getting Started* provides an overview of RFID technology and components, and a description of the MC919Z RFID mobile computer and features.
- *Chapter 2, Updating the RFID Mobile Computer* describes how to update the device image and radio firmware.
- *Chapter 3, MobileRFID Functionality* includes information on configuring the RFID radio and reading tags.
- *Chapter 4, RFID Sample Application* provides information on the RFID sample application and how to use it to assist in custom application development.
- *Chapter 5, Tag Locator* provides information on the application used to detect the location of a tag.
- *Chapter 6, Troubleshooting* describes MC919Z RFID mobile computer troubleshooting procedures.
- *Appendix A, Technical Specifications* includes the technical specifications for the reader.
- *Appendix B, RFID APIs* provides a reference for information on supported RFID APIs.

---

## Notational Conventions

The following conventions are used in this document:

- “Mobile computer” refers to the MC919Z hand-held computer.
- *Italics* are used to highlight the following:
  - Chapters and sections in this guide
  - Related documents
- **Bold** text is used to highlight the following:
  - Dialog box, window and screen names
  - Drop-down list and list box names
  - Check box and radio button names
  - Icons on a screen
  - Key names on a keypad
  - Button names on a screen.
- Bullets (•) indicate:
  - Action items
  - Lists of alternatives
  - Lists of required steps that are not necessarily sequential.
- Sequential lists (e.g., those that describe step-by-step procedures) appear as numbered lists.

---

## Related Documents and Software

The following documents provide more information about the MC919Z.

- *MC919Z Quick Start Guide*, p/n 72-152191-xx
- *MC919Z Regulatory Guide*, p/n 72-157453-xx
- *MC9190-G User Guide*, p/n 72E-140936-xx
- *MC9190-G Integrator Guide*, p/n 72E-140937-xx
- *Enterprise Mobility Developer Kits*, available at: <http://www.zebra.com/support>.
- Microsoft Sync software, available at: <http://www.microsoft.com>.

For the latest version of this guide and all guides, go to: <http://www.zebra.com/support>.

---

## Service Information

If you have a problem with your equipment, contact Zebra for your region. Contact information is available at: <http://www.zebra.com/support>.

When contacting Zebra support, please have the following information available:

- Serial number of the unit
- Model number or product name
- Software type and version number

Zebra responds to calls by e-mail, telephone or fax within the time limits set forth in service agreements.

If your problem cannot be solved by Zebra support, you may need to return your equipment for servicing and will be given specific directions. Zebra is not responsible for any damages incurred during shipment if the approved shipping container is not used. Shipping the units improperly can possibly void the warranty.

If you purchased your business product from a Zebra business partner, please contact that business partner for support.



# Chapter 1 Getting Started

---

## Introduction

This chapter provides an overview of RFID technology and components, and describes the MC919Z RFID mobile computer and product features.

---

## RFID Technology Overview

RFID (Radio Frequency Identification) is an advanced automatic identification (Auto ID) technology that uses radio frequency signals to identify *tagged* items. An RFID tag contains a circuit that can store data. This data may be pre-encoded or can be encoded in the field. The tags come in a variety of shapes and sizes.

To read a tag, the mobile computer sends out radio frequency waves using its integrated antenna. This RF field powers and charges the tags, which are tuned to receive radio waves. The tags use this power to modulate the carrier signal. The reader interprets the modulated signal and converts the data to a format for computer storage. The computer application translates the data into an understandable format.

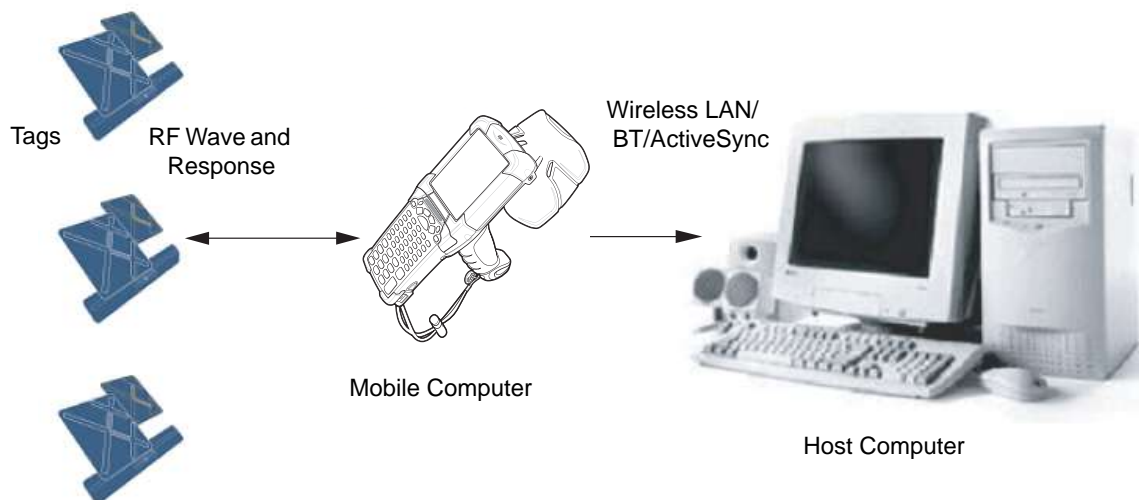

**Figure 1-1** RFID System Elements

## RFID Components

Zebra RFID solutions offer low cost, long read range, and a high read rate. These features provide real time end-to-end visibility of products and assets in the factory, distribution center, retail outlet, or other facility. The MC919Z RFID system consists of the following components:

- Silicon-based RFID tags that attach to retail products, vehicles, trailers, containers, pallets, boxes, etc.
- An integrated antenna that supports applications such as item level tracking and asset tracking.
- An embedded radio module that powers and communicates with tags for data capture and provides host connectivity for data migration.

### Tags

Tags contain embedded chips that store unique information. Available in various shapes and sizes, tags, often called transponders, receive and respond to data requests. Tags require power to send data.

There are several categories of tags based on the protocol they support, read/write memory, and power options:

- Active RFID tags are powered by internal light-weight batteries, and also use these batteries to broadcast radio waves to the reader.
- Semi-passive RFID tags are also powered by internal light-weight batteries, but draw broadcasting power from the reader.
- Passive RFID tags are powered by a reader-generated RF field. These tags are much lighter and less expensive than active tags, and are typically applied to less expensive goods.

### Antenna

Antennas transmit and receive radio frequency signals.

### Radio Module

The radio module communicates with the tags and transfers the data to a host computer. It also provides features such as filtering, CRC check, and tag writing. The MC919Z RFID mobile computer supports standard RFID tags as described by EPCGlobal™ Class 1 Gen2 protocol.



---

## MC919Z RFID Mobile Computer

The Zebra MC919Z RFID mobile computer includes an intelligent C1G2 UHF RFID reader with RFID read performance that provides real-time, seamless EPC-compliant tag processing. MC919Z RFID mobile computers are designed for back room inventory management, manufacturing floors, inside/outside loading dock and asset tracking applications, and can host third-party, customer-driven embedded applications. Features include:

- ISO 18000-6C standard (EPC Class 1 Gen 2)
- Read, write, kill, lock, block write/block erase, and permalock functionality
- 53-key alphanumeric keypad
- 3.7" VGA color display
- Touch panel with 340 dpi resolution
- Orientation-insensitive integrated external RFID antenna
- Reads 1D and 2D bar codes
- Windows® Mobile 6.5
- WLAN 802.11 a/b/g wireless connectivity
- Application-specific setup for ease of installation
- Low Level Reader Protocol (LLRP) - For LLRP custom extensions, refer to the *Software Interface Guide p/n 72E-131718-XX*.
- Sample application and support for custom or third-party applications
- RFID API support
- Event and tag management support

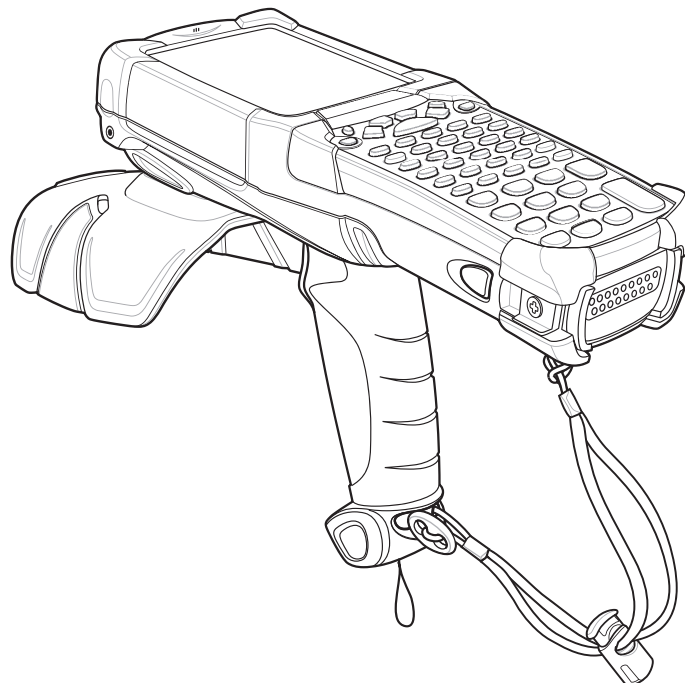

**Figure 1-2** MC919Z RFID Mobile Computer

## MC919Z Parts

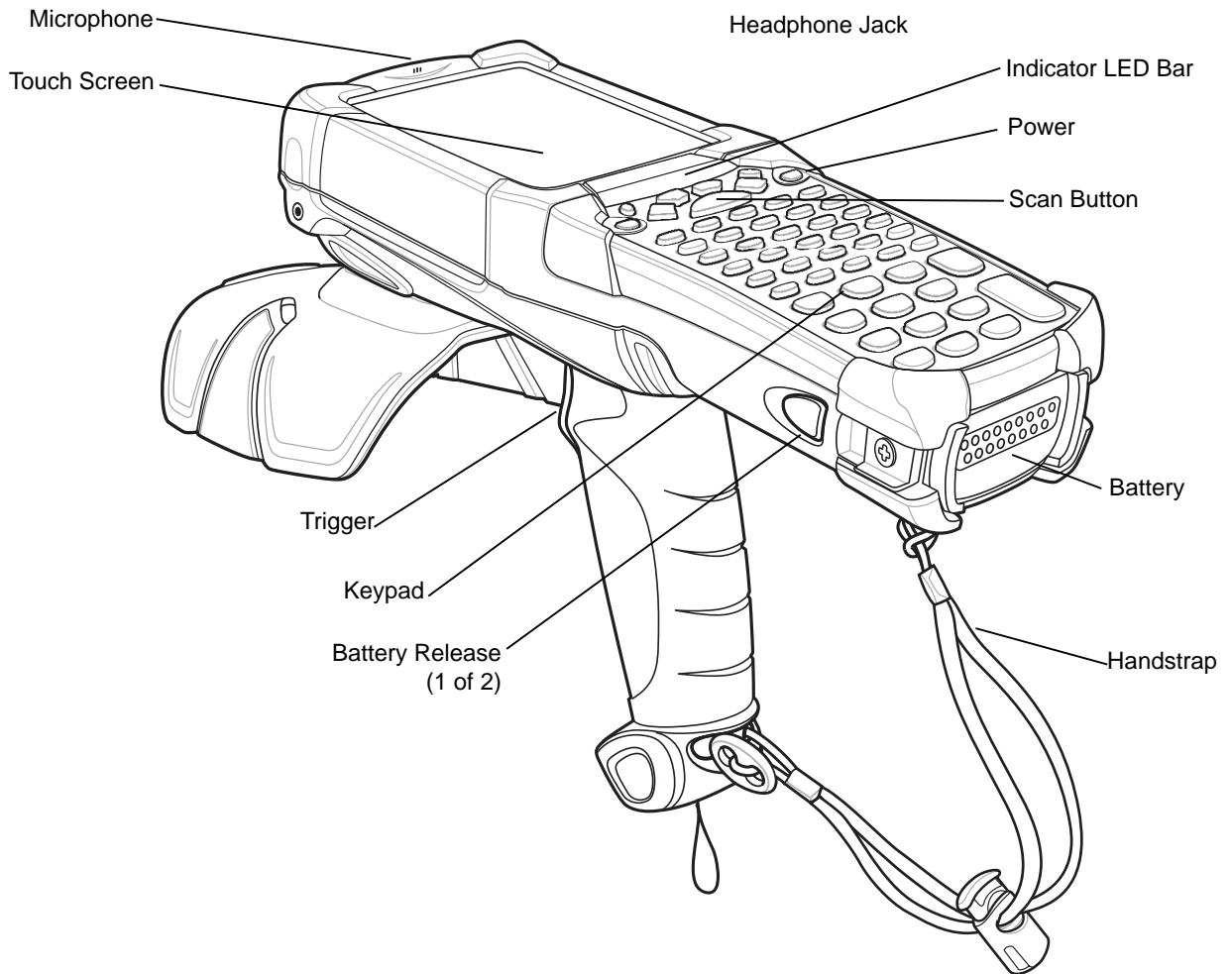

Figure 1-3 MC919Z Parts

## MC919Z LED Indicators

The LEDs indicate charging and reader status as described in [Table 1-1](#).

**Table 1-1** MC919Z LED Status Indicators

LED	Indication
<b>Charging Indicators</b>	
Off	Mobile computer not placed correctly in the cradle; cable not connected correctly; charger not powered.
Fast Blinking Amber	Error in charging; check placement of mobile computer.
Slow Blinking Amber	Mobile computer is charging.
Solid Amber	Charging complete. Note: When the battery is initially inserted in the mobile computer, the amber LED flashes once if the battery power is low or the battery is not fully inserted.

## Reading Tags

To read RFID tags:

1. Remove the MC919Z from AC power and ensure the LLRP icon is green.

✓ **NOTE** When connected to power, the mobile computer cannot read RFID tags.

2. Use an RFID reader application to enable tag reading. For a sample application, tap on icon RFID Demo in the start menu, or browse to the MC919Z **Application** directory and select **CS\_RFID3Sample6.exe**. See [RFID Sample Application on page 4-1](#).
3. Aim the mobile computer at the tag, oriented horizontally or vertically depending on the tag orientation. The distance between the tag and the antenna is the approximate read range.

Press the trigger or tap the on-screen **Read** command within the application to interrogate all RFID tags within the radio frequency (RF) field of view and capture data from each new tag found. Release the trigger or tap the **Stop Read** command to stop interrogating tags.



# Chapter 2 Updating the RFID Mobile Computer

---

## Introduction

This chapter describes how to update the device image and radio firmware.

---

## Updating the Device Image

Windows Mobile contains an Image Update feature that updates all operating system components. Zebra distributes all updates as update packages on the Support Central Web Site <http://www.zebra.com/support>. These packages contain either partial or complete updates for the operating system.

To update an operating system component, copy the update package to the mobile computer using ActiveSync or MSP.

## Downloading an Update Loader Package

1. Download the appropriate update loader package from the Zebra Support Central web site <http://www.zebra.com/support> to a host computer.
2. Locate the update loader package file on the host computer and un-compress the file into a separate directory: **9190w65HenULxxxxx.zip** for updating via ActiveSync

## Updating Images via ActiveSync

To install an update loader package using ActiveSync:

1. Insert the mobile computer into the cradle and connect the cradle to AC power.
2. Connect the mobile computer to the host computer using ActiveSync.
3. In ActiveSync on the host computer, open **Explorer** on the mobile computer.
4. Copy the contents of **xxxxw65xenULxxxxx\UpdateLoader** (the files only, not the folder) into the **\Storage Card** folder on the mobile computer. For example, the name for the MC9190Z is 9190w65HenUL024103\UpdateLoader.

5. On the mobile computer, navigate to the **\Storage Card** folder and tap the program **STARTUPDLDR.EXE**. The update takes approximately 10 minutes. Do not remove AC power during this time.
6. Copy **MCRFIDInstall\_x.x.x.CAB** into the **\Storage Card** folder on the mobile computer.
7. On the mobile computer, navigate to the **\Storage Card** folder and tap **MCRFIDInstall\_x.x.x.CAB**. The device reboots after the installation with RFID operational.

---

## Updating the RFID Firmware

The RFID\_FLASH utility, used to update the RFID radio firmware, is no longer provided. For related issues, contact Zebra support.

# Chapter 3 MobileRFID Functionality

---

## Introduction

MobileRFID is an RFID server application that runs in the background on the mobile computer. The MobileRFID icon appears in the system tray. This chapter includes information on using and configuring MobileRFID.





**Figure 3-1** *MobileRFID Icon*

---

## MobileRFID Icons

The MobileRFID icon indicates RFID radio status as described in [Table 3-1](#).

**Table 3-1** *MobileRFID Icon Indicators*

Icon	Indication
	RFID running, radio on.
	RFID running, radio off.
	RFID stopped (radio not found/battery critical/stopped from user interface).



## MobileRFID Menu

If using RFID as the Windows default home screen, tap the RFID panel, then tap the **Settings** button.

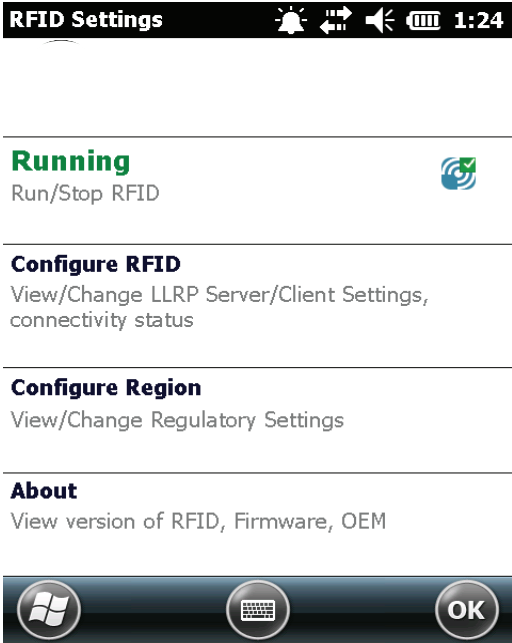

Figure 3-2 MobileRFID Home Window and Settings Window

If not using RFID as the Windows default home screen, tap the MobileRFID icon in the system tray. A menu appears.



Figure 3-3 MobileRFID Icon Menu

## Configure Region

### Upon Startup

After upgrading the mobile computer, the following window appears on startup.



Figure 3-4 Country Not Set Window

1. Tap **ok**. When no country is selected, the **Region Configuration** window appears.



Figure 3-5 Region Configuration Window

2. Select the **Region of Operation** and **Communication Standard** as allowed by the regulatory standards of that country/region from the drop-down menus. The following warning message appears.



Figure 3-6 Region Selection Warning Message

3. Tap **Yes** to confirm. A window appears indicating success.

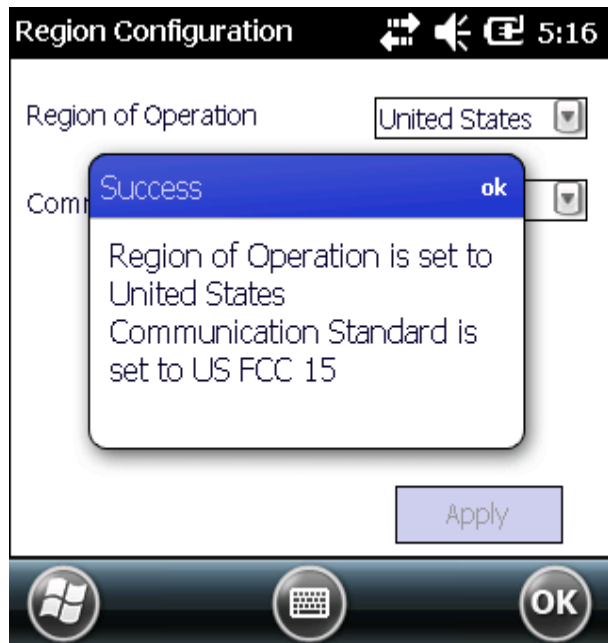

Figure 3-7 Region Selection Success Window

### After Startup

If not done at startup, set the regulatory region as follows:

1. Invoke the MobileRFID menu, then tap **Configure Region**.
2. In the **Region Configuration** window, select a region from the **Region of Operation** drop-down menu.



**Figure 3-8** Region Configuration Window

3. Tap **Yes** on the warning window that appears. A confirmation window appears upon successful completion.

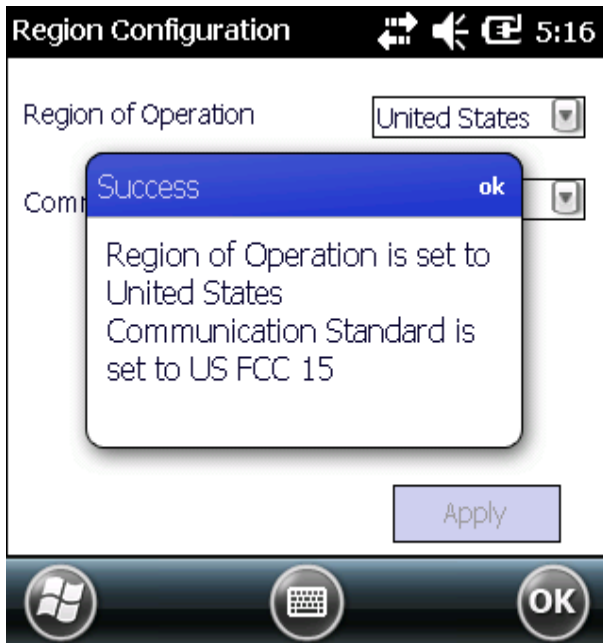

**Figure 3-9** Region Selection Success Window

4. Tap **OK**.

## Configure RFID

RFID is in Server Mode by default. To configure RFID to operate in Client Mode:

1. Invoke the MobileRFID menu, then tap **Configure RFID**.

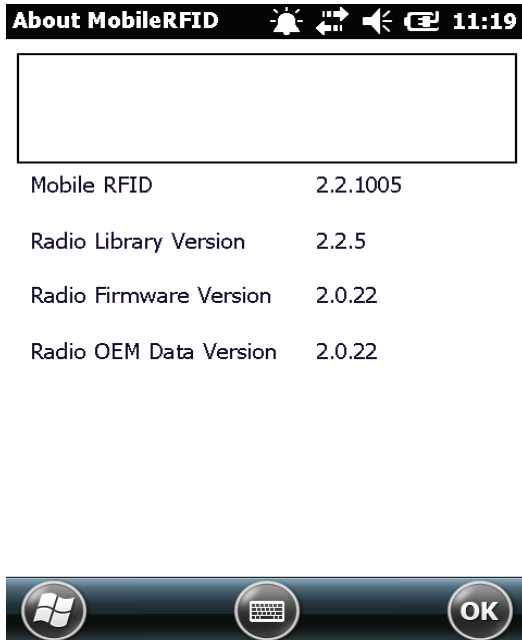

**Figure 3-10** RFID Configuration Window

2. Select the **Client Mode** check box.
3. In the **LLRP Port** field, enter the port number on which the server waits for the RFID client to communicate. The default is 5084.
4. In the **Server IP** field, enter the server IP for the remote host to which RFID communicates as a client.
5. Tap **Apply**.
6. Tap **OK** to close the window.

## Version Information

To view software version information for the RFID application, invoke the MobileRFID menu, then tap **About**.



**Figure 3-11** *About MobileRFID Window*

This window displays the MobileRFID application version, radio library version, radio firmware version, and radio OEM data version.



**NOTE** The version information in [Figure 3-11](#) may differ from the information on the actual mobile computer screen.

### Run/Stop RFID

To stop RFID service, tap **Stop** in MobileRFID menu.

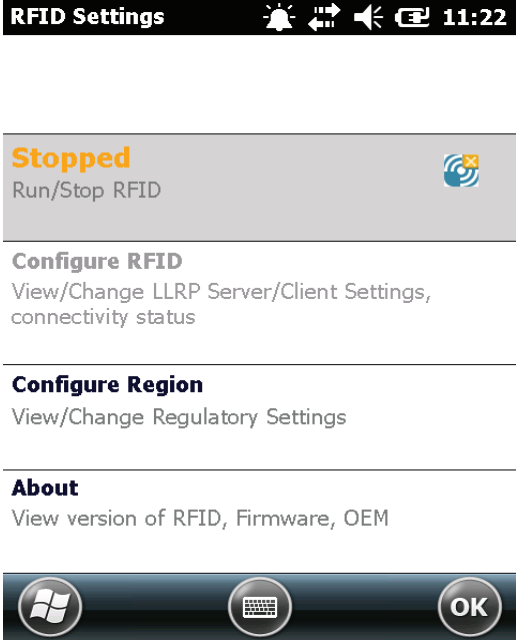

Figure 3-12 RFID Stopped

To restart RFID, tap **Run** in MobileRFID menu.





# Chapter 4 RFID Sample Application

---

## Introduction

The RFID Application CS\_RFID3Sample6.exe provides an overview of how the application works and assists application developers in developing custom applications.

The mobile computer can read, write, lock, kill, and program Gen2 tags. Each tag contains the EPC number (64 or 96 bits), CRC, and kill code. The mobile computer can also collect data by decoding in-range EPC Gen2 RFID tags.

Initiating the read command within the sample application causes the mobile computer to interrogate all RFID tags within the radio frequency (RF) field of view. The reader captures data from each new tag and adds it to the list box in the **EPC ID** window. Select **Stop Read** to stop interrogating tags.

## Launching the RFID Sample Application

Select **RFID Demo** in the **Start** menu to start the RFID sample application.



Figure 4-1 RFID Demo Icon



Figure 4-2 RFID Sample Application Window

In the sample application window:

- Tap the **Start Reading** button to initiate the tag read. Tap **Stop Reading** to terminate tag reading.
- Use the **Mem Bank** drop-down to select a tag memory bank to read. The default memory bank is **EPC (None)**. Other options are **TID**, **Reserved**, and **User**.

---

## Connection

Tap **Connection** to display the reader IP and port number.

Select **Disconnect** to disconnect the reader.



**Figure 4-3** Connection Window

## Capabilities

Select **Menu > Capabilities** to view the capabilities of the connected reader.

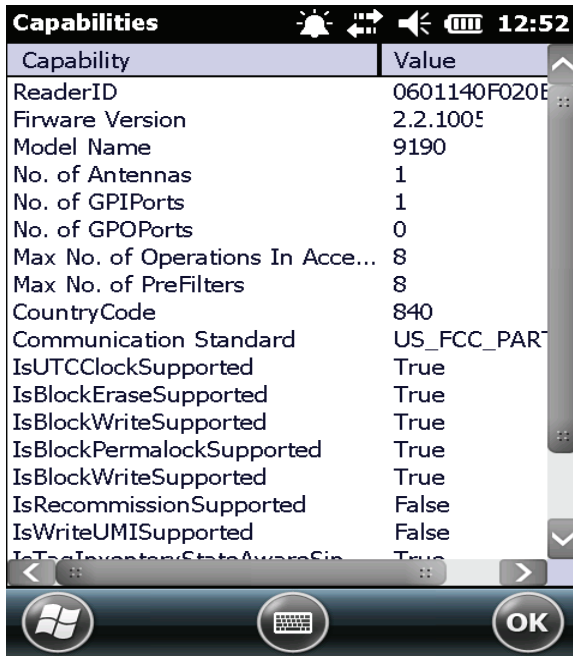

Capability	Value
ReaderID	0601140F020E
Firmware Version	2.2.100E
Model Name	9190
No. of Antennas	1
No. of GPIPorts	1
No. of GPOPorts	0
Max No. of Operations In Acce...	8
Max No. of PreFilters	8
CountryCode	840
Communication Standard	US_FCC_PART
IsUTCclockSupported	True
IsBlockEraseSupported	True
IsBlockWriteSupported	True
IsBlockPermalockSupported	True
IsBlockWriteSupported	True
IsRecommissionSupported	False
IsWriteUMISupported	False
IsTagInventoryStateAwareSin	True

Figure 4-4 Capabilities Window

## Configuration Menu Options

The Configuration Menu includes the following options:

- Tag Storage Settings
- Antenna
- RF Mode
- Singulation
- Power On/Off Radio
- Reset to Factory Defaults

### Tag Storage Settings

Select **Menu > Config > Tag Storage Settings** to view/configure tag storage settings.

**Tag Storage Settings** 🔔 🔌 🔊 🔋 12:53

Maximum Tag Count	<input type="text" value="4096"/>
Max Tag ID Length (Bytes)	<input type="text" value="64"/>
Max Size of Memory Bank (Bytes)	<input type="text" value="64"/>

**Apply**



**Figure 4-5** *Tag Storage Settings Window*

The **Tag Storage Settings** window includes the following fields:

- **Maximum Tag Count** - The maximum number of tags to store in the DLL.
- **Max Tag ID Length** - The maximum tag length.
- **Max Size of Memory Bank** - Storage to allocate for the memory bank data.
- **Apply** - Apply configuration changes.

## Antenna

Select **Menu > Config > Antenna** to view/configure the antenna.

**Antenna Config** 7:27

Antenna ID: 1

Receive Sensitivity (dB): 0

Transmit Power (dBm): 2700

Hop Table Index: 1

915750, 915250, 903250, 926750,  
926250, 904250, 927250, 920250

Apply

Windows Keyboard OK

**Figure 4-6** *Antenna Configuration Window*

The **Antenna Configuration** window includes the following fields:

- **Antenna ID** - Select an antenna ID to update the configuration values in the other fields.
- **Receive Sensitivity (dB)** - Lists the reader-supported values for the selected antenna.
- **Transmit Power (dBm)** - Lists the reader-supported values for the selected antenna.
- **Hop Table Index** - Updates the Hop Frequency list with the corresponding frequencies.
- **Apply** - Apply configuration changes.

## RF Mode

Select **Menu > Config > RF Mode** to view/configure the RF mode for each antenna.

RF Mode 7:29

Antenna ID 1

Tari Value 0

RF Mode Table 0

Parameter	Value
Mode Identifier	18
DR	DR_64_3
Bdr	62500
M	MV 4

Apply

Windows Keyboard OK

**Figure 4-7** RF Mode Window

The **RF Mode** window includes the following fields:

- **Antenna ID** - Select an antenna ID to update the configuration values in the other fields.
- **Tari Value** - TARI specified in nsec.
- **RF Mode Table** - RF mode table configured for the current antenna.
- **Apply** - Select to apply configuration changes.

## Singulation

Select **Menu > Config > Singulation** to view/configure the singulation control settings for each antenna.

**Singulation** 7:29

Antenna ID: 1

Session: S0

Tag Population: 100

Tag Transit Time: 0

State Aware

Inventory State: STATE A

SL Flag: DEASSERTED

Apply

Windows, Keyboard, OK

**Figure 4-8** Singulation Control Settings Window

This **Singulation** settings window includes the following fields:

- **Antenna ID** - Select an antenna ID to update the configuration values in the other fields.
- **Session** - The session number for the inventory operation.
- **Tag Population** - The approximate tag population in the RF field of the antenna.
- **Tag Transit Time** - The time in milliseconds that the tag typically remains in the RF field of the antenna.
- **State Aware** - Indicates if the antenna performs state aware or state unaware singulation.
- **Inventory State** - Select a tag of state A or B. Valid only for State Aware singulation.
- **SL Flag** - Valid only for State Aware singulation
- **Apply** - Apply configuration changes.



## Power On/Off Radio

Select **Menu > Config > Power On/Off Radio** to change the power settings of the RFID radio.



Figure 4-9 Radio Power Settings Menu

## Reset to Factory Default

Select **Menu > Config > Reset to Factory Default** to restore the default reader configuration.

## Operations Menu Options

The **Operations Menu** includes the following options:

- Antenna Info
- Filter
- Access
- Triggers

### Antenna Info

Select **Menu > Operations > Antenna Info** to view/configure the list of antennas that can be used for inventory/access operations.

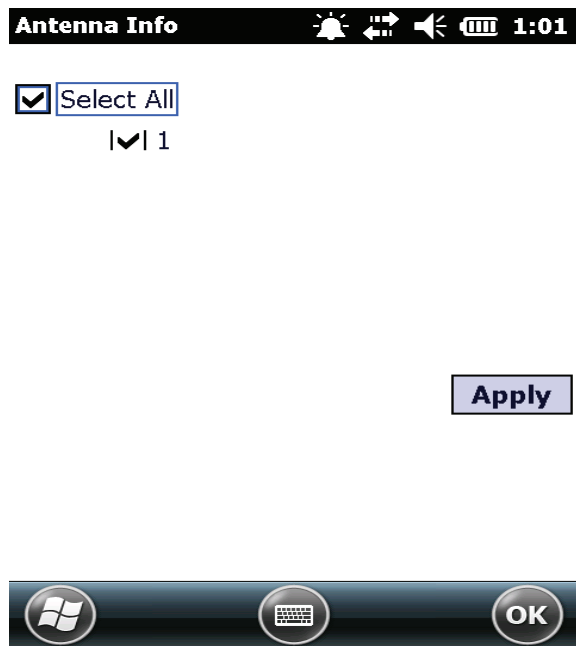

Figure 4-10 *Antenna Info Window*

## Filter

Select **Menu > Operations > Filter** to view/configure the following filters:

- Pre-Filter
- Post-Filter
- Access-Filter

### Pre-Filter

Select **Menu > Operations > Filter > Pre-Filter** to view/configure pre-filters.

The screenshot shows the 'PreFilter' window with the following configuration:

- Antenna ID:** 1 (selected),  Use Filter 1
- Memory Bank:** EPC (selected), **Offset:** 32
- Tag Pattern:** aabbccdd
- Filter Action:** STATE AWARE (selected)
- Action:** INV A NOT INV B (selected), **Target:** S0 (selected)

At the bottom, there is a selector for 'Filter 1' and 'Filter 2', an 'Apply' button, and a navigation bar with icons for Windows, Keyboard, and OK.

**Figure 4-11** PreFilter Window

This **Pre-Filter** window includes the following fields:

- **Antenna ID** - Select an antenna ID to update the configuration values in the other fields.
- **Memory Bank** - Memory bank on which the filter is applied.
- **Offset** - The first (msb) bit location of the specified memory bank against which to compare the tag mask.
- **Tag Pattern** - The pattern against which to compare the specified memory bank.
- **Filter Action** - Select the required filter action. For more information, refer to the Gen2 specification available at <http://www.epcglobalinc.org/standards/>.

## Post-Filter

Select **Menu > Operations > Filter > Post-Filter** to view/configure post-filters.

The screenshot shows the 'PostFilter' configuration window. The title bar includes the text 'PostFilter' and icons for back, forward, and a battery level indicator, along with the time '7:33'. The main area contains the following fields:

- Memory Bank:** A dropdown menu with 'USER' selected.
- Offset:** A text input field containing the number '2'.
- Tag Pattern:** A text input field containing 'aabb'.
- Tag Mask:** A text input field containing 'fff'.

Below these fields are two tabs: 'Tag Pattern A' (selected) and 'Tag Pattern B'. Under the 'Tag Pattern A' tab, there is a 'Match Pattern' dropdown menu with 'A AND B' selected. To the left of the 'Apply' button is a checked checkbox labeled 'Use Filter'. The 'Apply' button is located to the right of the 'Use Filter' checkbox. At the bottom of the window, there is a dark green bar containing three circular icons: the Windows logo, a keyboard icon, and an 'OK' button.

**Figure 4-12** *Post-Filter Window*

This **Post-Filter** window includes the following fields:

- **Memory Bank** - Memory bank on which the filter is applied.
- **Offset** - The first (msb) bit location of the specified memory bank against which to compare the tag mask.
- **Tag Pattern** - The pattern against which to compare the specified memory bank.
- **Tag Mask** - The bit mask to facilitate bit wise filtering.
- **Match Pattern** - Select the tag pattern to match (A, B, both, or neither).

## Access-Filter

Select **Menu > Operations > Filter > Access-Filter** to view/configure the access-filters.

The screenshot shows the 'AccessFilter' configuration window. The title bar includes the text 'AccessFilter' and system icons for connectivity, volume, battery, and the time '7:39'. The main area contains the following fields:

- Memory Bank:** A dropdown menu with 'EPC' selected.
- Offset:** A text input field containing the value '32'.
- Tag Pattern:** A text input field containing the value '11223344'.
- Tag Mask:** A text input field containing the value 'fffffff'.

Below these fields is a tabbed interface with two tabs: 'Tag Pattern A' (selected) and 'Tag Pattern B'. Under the 'Tag Pattern A' tab, there is a 'Match Pattern' dropdown menu with 'A' selected. To the left of the 'Match Pattern' dropdown is a checked checkbox labeled 'Use Filter'. To the right of the 'Match Pattern' dropdown is an 'Apply' button. At the bottom of the window is a navigation bar with three circular icons: the Windows logo, a keyboard icon, and an 'OK' button.

**Figure 4-13** Access-Filter Window

This **Access-Filter** window includes the following fields:

- **Memory Bank** - Memory bank on which the filter is applied.
- **Offset** - The first (msb) bit location of the specified memory bank against which to compare the tag mask.
- **Tag Pattern** - The pattern against which to compare the specified memory bank.
- **Tag Mask** - The bit mask to facilitate bit wise filtering.
- **Match Pattern** - Select the tag pattern to match (A, B, both, or neither).

## Access

Select **Menu > Operations > Access** to perform the following access operations.



**Figure 4-14** Access Menu

The **Access** menu includes the following options:

- Read
- Write
- Lock
- Kill
- Block Write
- Block Erase

To perform an access option on a single tag, right-click the tag in the list of read tags on the main window to invoke the tag's context menu.

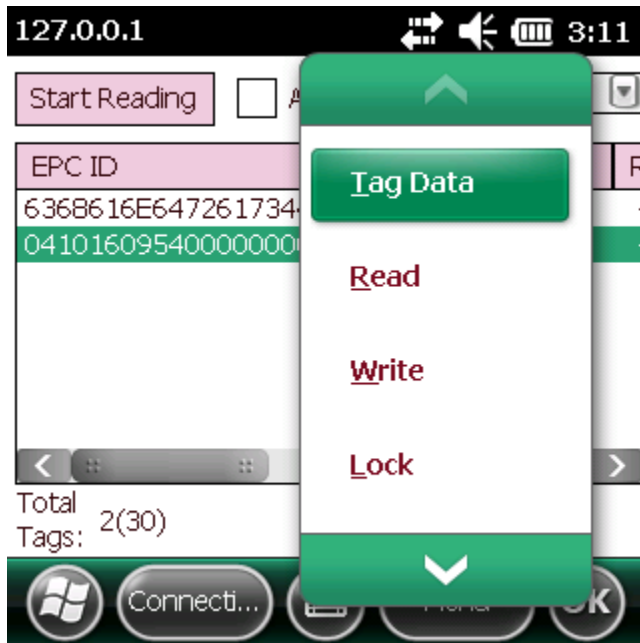

Figure 4-15 Tag Context Menu

### Access Operation Windows

The **Access Operation** windows include the following fields. Set options as required in the various parameter windows. Not all windows include all options.

- **Tag ID** - The name of the selected tag.
- **Password** - Set a password before performing any access operation (except *Kill*).
- **Memory Bank** - Select the memory bank (*Reserved, EPC, TID, User*)
- **Offset** - Offset of the first word to read from the selected memory bank.
- **Length** - Tag/data length.
- **Write Data** - The data to write to the selected tag (*Write* window only).
- **Lock Privilege** - Access options for the selected tag (*Write* window only):
  - **None** - Can not change the lock privilege of the particular memory bank.
  - **Read\_Write** - User can read and write to the tag.
  - **Perma\_Lock** - Permanent lock.
  - **Perma\_Unlock** - Permanent unlock.
  - **Unlock** - User can unlock the tag for writing.

**Read** 7:40

Tag ID (Hex)

Password (Hex)

Memory Bank

Offset (Bytes)  Length (Bytes)

Data Read (Hex)

**Figure 4-16** Read Access Operation Window

**Write Tags** 7:41

Tag ID (Hex)

Password (Hex)

Memory Bank

Offset (Bytes)  Length (Bytes)

Data (Hex)

**Figure 4-17** Write / Block-Write Access Operation Window



Lock

Tag ID (Hex) AD852200485283851400006

Password (Hex) 0

Memory Bank EPC MEMORY

Lock Privilege READ WRITE

Access Filter Lock

Windows Keyboard OK

Figure 4-18 Lock Access Operation Window

Kill

Tag ID (Hex) AD8522004852838514000061

Kill Password (Hex) 0

Access Filter Kill

Windows Keyboard OK

Figure 4-19 Kill Access Operation Window

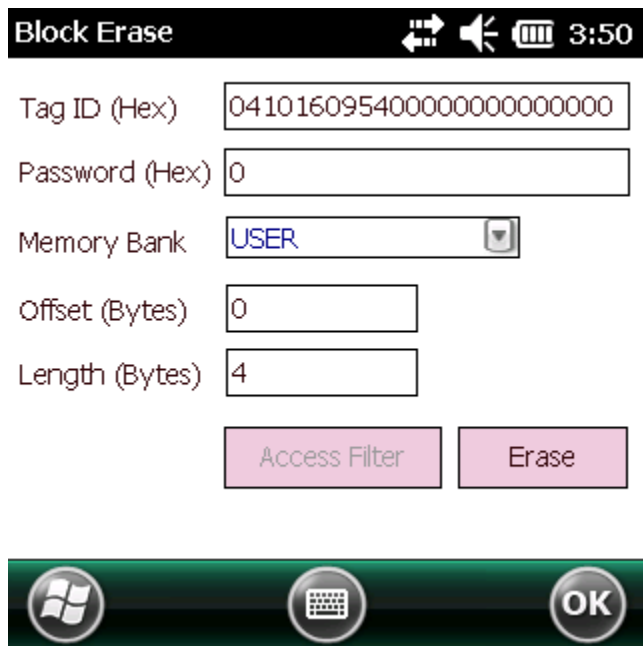

**Figure 4-20** *Block Erase Access Operation Window*

## Triggers

Select **Menu > Operations > Trigger** to view/configure the trigger.

Trigger

Trigger Type: Periodic

Start Date: Mar/31/11 07:20:24 PM

Period (ms): 1

Start Trigger Stop Trigger Report Trigger

Tag Report Trigger: 0 Apply



Windows Keyboard OK

**Figure 4-21** Start Trigger - Periodic Window

### Start Trigger

The Trigger Type in the Start Trigger window includes the following fields:

- **Immediate** - Start operation immediately.
- **Periodic** - Start operation at a specific time and repeat operation after a specified period in milliseconds.
- **GPI** - Start operation based on General Purpose Input. Handheld supports a single GPI which is the handheld trigger. If 'Low to High' event option is selected, operation starts when handheld trigger is pressed. If 'High to Low' event option is selected, operation starts when handheld trigger is released.
- **Handheld** - Start operation based on General Purpose Input. Handheld supports a single GPI which is the handheld trigger. If 'Low to High' event option is selected, operation starts when handheld trigger is pressed. If 'High to Low' event option is selected, operation starts when handheld trigger is released.

**Trigger**    7:43



Trigger Type

Start Date

Period (ms)

Start Trigger  Report Trigger

Tag Report Trigger

**Figure 4-22** Start Trigger - Periodic Window

**Trigger**    1:14

Trigger Type

Event

High To Low

Low To High

Start Trigger  Report Trigger

Tag Report Trigger

**Figure 4-23** Start Trigger - GPI Window

**Trigger**

Trigger Type

Event  Trigger Released  
 Trigger Pressed

Start Trigger

Tag Report Trigger

**Figure 4-24** Start Trigger - Handheld Trigger Window

**Stop Trigger**

Trigger 12:48

Trigger Type

Duration(ms)

Start Trigger Stop Trigger Report Trigger

Tag Report Trigger

Windows Keyboard OK

**Figure 4-25** Stop Trigger - GPI with Timeout Window

The **Trigger Type** in the **Stop Trigger** window includes the following fields:

- **Immediate** - Stop operation immediately.
- **Duration** - Stop operation after a duration specified in milliseconds.
- **GPI with Timeout** - Stop operation on General Purpose Input or after a timeout period specified in milliseconds, whichever happens first. Handheld supports a single GPI which is the handheld trigger. If 'Low to High' Event option is selected, operation stops when handheld trigger is pressed. If 'High to Low' event option is selected, operation stops when handheld trigger is released.
- **Tag Observation** - Stop operation after specific number of tag observations or a timeout specified in milliseconds, whichever happens first.
- **N Attempts** - Perform operation after specified number of attempts or a timeout specified in milliseconds, whichever happens first.
- **Handheld Trigger with Timeout** - Same as GPI with timeout

**Trigger**    12:48

Trigger Type

Port

Time Out

Event  High To Low  
 Low To High

Start Trigger Stop Trigger Report Trigger

Tag Report Trigger

**Figure 4-26** Stop Trigger - GPI with Timeout

**Trigger**    12:48

Trigger Type

Tag Observation

Time

Start Trigger Stop Trigger Report Trigger

Tag Report Trigger

**Figure 4-27** Stop Trigger - Tag Observation with Timeout Window



Figure 4-28 Stop Trigger - N Attempts with Timeout Window



Figure 4-29 Stop Trigger - Handheld Trigger with Timeout Window



## Report Trigger

The screenshot shows a 'Report Trigger' window with the following elements:

- Title Bar:** 'Trigger' on the left, and navigation icons (back, forward, home) and the time '12:56' on the right.
- Settings Rows:**
  - New Tag:** Dropdown menu set to 'Moderated', text box set to '500'.
  - Tag Invisible:** Dropdown menu set to 'Moderated', text box set to '500'.
  - Tag back to visibility:** Dropdown menu set to 'Moderated', text box set to '500'.
- Control Buttons:** A row of four buttons: 'Start Trigger', 'Stop Trigger', 'Report Trigger', and an unlabeled button.
- Bottom Section:** 'Tag Report Trigger' label, a text box containing '0', and an 'Apply' button.
- Bottom Bar:** Three circular icons: Windows logo, keyboard icon, and 'OK'.

**Figure 4-30** Report Trigger Window

Report settings are applicable when tag options are checked in the main window of the demo application. The following event generations are controlled by criteria settings in **Report Trigger**.

The events associated with a tag are as follows:

- **New Tag** - Tag seen by the reader for the first time.
- **Tag Invisible** - Tag which was in the field of view of the reader is now not seen.
- **Tag Back to Visibility** - An invisible tag has come back in field of view of reader.

Criteria selections are as follows:

- **Never** - Corresponding event is never reported.
- **Immediate** - Corresponding event is immediately reported when it happens.
- **Moderated** - Event is generated after monitoring for sustained occurrence of the event for a period of time specified in milliseconds.

---

## Management Menu Options

Management options are not applicable for handheld readers.

---

## Help Menu

Select **Menu > Help** to display the version information. The version numbers displayed in this window are examples. Actual version numbers are based on the versions of the files on the device.



About CS\_RFID3Sampl

CS\_RFID3Sample6

C-DII: 5.2.0.8, .NET-DII: 1.2.0.0

Copyright (C) 2010



Figure 4-31 Help Window

---

## Exit

Select **Menu > Exit** to exit the RFID sample application.

# Chapter 5 Tag Locator

---

## Introduction

Use Tag Locator to detect the location of a tag. By providing the TagID of an item, this application can find the relative position of the tag with respect to the mobile computer. Move the mobile computer back and forth to obtain the location of the tag as indicated by the beep frequency and a vertical progress bar showing the relative position of the tag.

The **Tag Locator** application requires the following components/DLLs on the device:

- RFIDAPI32.dll (Version 5.1.15 or higher)
- Symbol.RFID3.Device.dll (Assembly version 5.2.0.8, File version 1.2.0.0 or higher)
- Symbol.Audio.dll
- Symbol.dll
- Symbol.Notification.dll
- Symbol.StandardForms.dll

---

## Using Tag Locator

To use the Tag Locator application:

1. Tap **Tag Locator** in the **Application** folder on the mobile computer to open the Tag Locator application.



**Figure 5-1** *Tag Locator*

2. Enter the tag ID in one of three ways:

- Type the tag ID in the **TagID** text box, then select **Locate** or press and hold the trigger.
- Perform a search operation by selecting the **Search Tags** button or by pressing and holding the trigger.
- Select the **Import Tags** button to import a list of saved tags from a .csv file. See [Locating Tags Using a .csv File on page 5-3](#).

## Locating Tags Using a .csv File

1. Select the **Import Tags** button to import a list of saved tags from a .csv file. The following window appears.

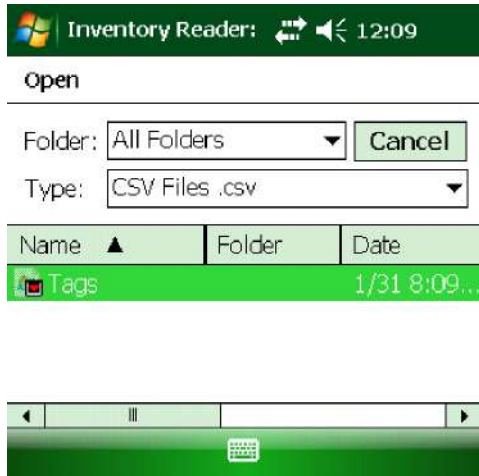

**Figure 5-2** Opening a .csv File

2. Select the desired .csv file to import the tags to the list.

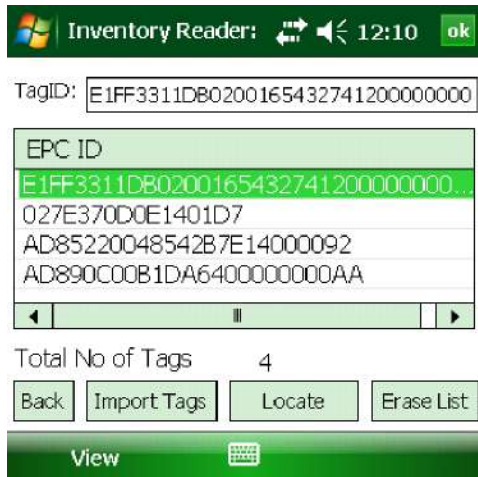

**Figure 5-3** Tag List

3. Select a tag from the list to search.

4. Select the **Locate** button or press and hold the trigger. Move the mobile computer in all directions to get the relative position of the tag, indicated by a beep, the vertical progress bar, or both.



**Figure 5-4** Tag Search

Use the **Options** menu to turn the beeper on and off and to display data in ASCII or hexadecimal format.

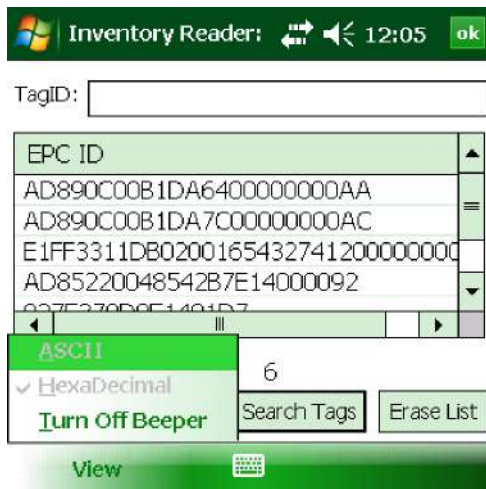

**Figure 5-5** Options Menu

# Chapter 6 Troubleshooting

---

## Introduction

This chapter provides troubleshooting solutions for potential problems during MC919Z operating.

---

## Troubleshooting

### MC919Z

**Table 6-1** *Troubleshooting the MC919Z*

Problem	Cause	Solution
MC919Z does not turn on.	Battery not charged.	Charge or replace the battery.
	Battery not installed properly.	Ensure battery is installed properly.
	System crash.	Perform a warm boot. If the MC919Z still does not turn on, perform a cold boot.
Rechargeable battery did not charge.	Battery failed.	Replace battery. If the MC919Z still does not operate, try a warm boot, then a cold boot. Refer to <i>Resetting the MC9190</i> in the <i>MC9190-G Integration Guide</i> .
	MC919Z removed from cradle while battery was charging.	Insert MC919Z in cradle and begin charging. The battery requires approximately four hours to recharge fully.
Cannot see characters on display.	MC919Z not powered on.	Press the <b>Power</b> button.

**Table 6-1** Troubleshooting the MC919Z (Continued)

Problem	Cause	Solution
During data communication, no data was transmitted, or transmitted data was incomplete.	MC919Z removed from cradle or unplugged from host computer during communication.	Replace the MC919Z in the cradle, or reattach the Synchronization cable and re-transmit.
	Incorrect cable configuration.	See the System Administrator.
	Communication software was incorrectly installed or configured.	Perform setup. Refer to refer to the <i>MC9190-G Integration Guide</i> for details. Ensure that Microsoft ActiveSync 4.5 or greater is installed on the host computer.
No sound is audible.	Volume setting is low or turned off.	Turn on or increase volume.
MC919Z turns itself off.	MC919Z is inactive.	The MC919Z turns off after a period of inactivity. If the MC919Z is running on battery power, this period can be set to 30 sec., 1, 2, 3, 4, 5 or 6 minutes. If the MC919Z is running on external power, this period can be set to 1, 2, 3, 5, 10, 15 and 30 minutes. For Windows Mobile 6.5 devices, Check the power settings by tapping <b>Start &gt; Settings &gt; System &gt; Power &gt; Advanced</b> . Change the setting if you need a longer delay before the automatic shutoff feature activates.
	Battery is depleted.	Replace the battery.
	Battery is not inserted properly.	Insert the battery properly.
Tapping the window buttons or icons does not activate the corresponding feature.	LCD screen not aligned correctly.	Re-calibrate the screen.
	The system is hung.	Warm boot the system. To perform a warm boot (refer to <i>Resetting the MC9190-G</i> in the <i>MC9190-G Integration Guide</i> ).
A message appears stating that the MC919Z memory is full.	Too many files stored on the MC919Z.	Delete unused memos and records. You can save these records on the host computer.
	Too many applications installed on the MC919Z.	If you have installed additional applications on the MC919Z, remove them to recover memory. For Windows Mobile 6.5 devices, tap <b>Start &gt; Settings &gt; System &gt; Remove Programs</b> . Select the unused program and tap <b>Remove</b> .



**Table 6-1** *Troubleshooting the MC919Z (Continued)*

Problem	Cause	Solution
The MC919Z does not accept scan input.	Scanning application is not loaded.	Verify that the MC919Z is loaded with a scanning application. See the System Administrator.
	Unreadable bar code.	Ensure the symbol is not defaced.
	Distance between exit window and bar code is incorrect.	Ensure MC919Z is within proper scanning range.
	MC919Z is not programmed for the bar code.	Ensure the MC919Z is programmed to accept the type of bar code being scanned.
	MC919Z is not programmed to generate a beep.	If a beep on a good decode is expected and a beep is not heard, check that the application is set to generate a beep on good decode.
	Battery is low.	If the scanner stops emitting a laser beam when the trigger is pressed, check the battery level. When the battery is low, the scanner shuts off before the MC919Z low battery condition notification. Note: If the scanner is still not reading symbols, contact the distributor or Zebra.

## Bluetooth Connection

**Table 6-2** *Troubleshooting Bluetooth Connection*

Problem	Cause	Solution
MC919Z cannot find any Bluetooth devices nearby.	Too far from other Bluetooth devices.	Move closer to the other Bluetooth device(s), within a range of 10 meters (30 feet).
	The Bluetooth device(s) nearby are not turned on.	Turn on the Bluetooth device(s) you wish to find.
	The Bluetooth device(s) are not in discoverable mode.	Set the Bluetooth device(s) to discoverable mode. If needed, refer to the device's user documentation for help.
MC919Z keeps powering down to protect memory contents.	The MC919Z's battery is low.	Recharge the battery.
There is a delay in the Bluetooth stack re-initializing during a resume from suspend.	This is the normal behavior.	No solution required.

## Four Slot Charge Only Cradle

**Table 6-3** *Troubleshooting the Four Slot Charge Only Cradle*

Problem	Cause	Solution
MC919Z charge indicator LED does not light.	Cradle is not receiving power.	Ensure the power supply is securely connected and receiving power.
	MC919Z is not seated correctly in the cradle.	Ensure the battery is properly installed in the MC919Z, and re-seat the MC919Z in the cradle.
	The battery is not properly installed in the MC919Z.	
	The battery in the MC919Z is faulty.	Verify that other batteries charge properly. If so, replace the faulty battery.

Note: The Four Slot Charge Only Cradle has no power indication.

## Four Slot Ethernet Cradle

**Table 6-4** *Troubleshooting the Four Slot Ethernet Cradle*

Symptom	Cause	Solution
Attempt by the MC919Z to ActiveSync failed.	Cannot perform ActiveSync connection.	ActiveSync over an Ethernet connection is not available with Windows Mobile 6.5 and ActiveSync 4.5.
During communications, no data was transmitted, or transmitted data was incomplete.	MC919Z removed from cradle during communications.	Replace MC919Z in cradle and retransmit.
	MC919Z has no active connection.	An icon will be visible in the status bar if a connection is currently active.
MC919Z has successfully connected through the cradle, but no data is being transmitted over the connection.	Data is being transferred over the wireless link.	Temporarily disable the WLAN connection to force data transmission through the cradle. Once you have completed your data transmission, re-enable the WLAN connection.

**Table 6-4** Troubleshooting the Four Slot Ethernet Cradle (Continued)

Symptom	Cause	Solution
All Communication Status LEDs are flashing red.	The cradle could not configure itself, or it has lost the lease on its IP address.	Connect the cradle to an Ethernet network with a correctly functioning DHCP server.
	Failed automatic cradle configuration via local DHCP service.	Connect a properly configured DHCP server or DHCP relay agent to the subnet, and power cycle the cradle. Check the DHCP server log to verify that the cradle is receiving a response to its DHCP request.
	The Ethernet link may be down.	Ensure the ethernet cable is connected to an active hub.
Communication Status LED does not light up.	MC919Z has been inserted incorrectly into the cradle.	Remove, wait a minute, and then reinsert the MC919Z, ensuring it fits snugly onto the connector at the bottom of the cradle.
	Cradle is not receiving power.	Ensure the power supply is securely connected and receiving power.
Battery is not recharging.	MC919Z removed from the cradle too soon.	Replace the MC919Z into the cradle. It can take up to four hours to recharge a completely depleted battery pack if MC919Z is suspended or longer if the MC919Z is on. For Windows Mobile 6.5 devices, view battery status by tapping <b>Start &gt; Settings &gt; System &gt; Power</b> .
	Battery is faulty.	Verify that other batteries charge properly. If so, replace the faulty battery.
	MC919Z is not inserted correctly into the cradle.	Remove the MC919Z and reinsert it correctly. Verify charging is active. For Windows Mobile 6.5 devices, view battery status by tapping <b>Start &gt; Settings &gt; System &gt; Power</b> .
Warning Message - "!" Unable to obtain a server assigned IP address. Try again later or enter an IP address in Network Settings."	This message occurs if a suspend/resume cycle is performed and the MC919Z is not associated (e.g. due to being out of range).	Tap <b>OK</b> to close the message. The MC919Z will obtain address information and communicate through the ethernet cradle.

## Four Slot Spare Battery Charger

**Table 6-5** *Troubleshooting The Four Slot Spare Battery Charger*

Symptom	Possible Cause	Action
Batteries not charging.	Battery was removed from the charger or charger was unplugged from AC power too soon.	Ensure the charger is receiving power. Confirm main battery is charging. If a battery is fully depleted, it can take up to four hours to fully recharge a battery.
	Battery is faulty.	Verify that other batteries charge properly. If so, replace the faulty battery.
	Battery contacts not connected to charger.	Verify that the battery is seated in the battery well correctly with the contacts facing down.

## Single Slot Serial/USB Cradle

**Table 6-6** *Troubleshooting the Single Slot Serial/USB Cradle*

Symptom	Possible Cause	Action
LEDs do not light when MC919Z or spare battery is inserted.	Cradle is not receiving power.	Ensure the power cable is connected securely to both the cradle and to AC power.
	MC919Z is not seated firmly in the cradle.	Remove and re-insert the MC919Z into the cradle, ensuring it is firmly seated.
	Spare battery is not seated firmly in the cradle.	Remove and re-insert the spare battery into the charging slot, ensuring it is firmly seated.
MC919Z battery is not charging.	MC919Z was removed from cradle or cradle was unplugged from AC power too soon.	Ensure cradle is receiving power. Ensure MC919Z is seated correctly. Confirm that the battery is charging. If a MC919Z battery is fully depleted, it can take up to four hours to fully recharge a battery (if the MC919Z is off and longer if the MC919Z is operating). For Windows Mobile 6.5 devices, view battery status by tapping <b>Start &gt; Settings &gt; System tab &gt; Power</b> .
	Battery is faulty.	Verify that other batteries charge properly. If so, replace the faulty battery.
	The MC919Z is not fully seated in the cradle.	Remove and re-insert the MC919Z into the cradle, ensuring it is firmly seated.
Spare battery is not charging.	Battery not fully seated in charging slot.	Remove and re-insert the spare battery into the cradle, ensuring it is firmly seated.
	Battery inserted incorrectly.	Ensure the contacts are facing down and toward the back of the cradle.
	Battery is faulty.	Verify that other batteries charge properly. If so, replace the faulty battery.

**Table 6-6** Troubleshooting the Single Slot Serial/USB Cradle (Continued)

Symptom	Possible Cause	Action
During data communications, no data was transmitted, or transmitted data was incomplete.	MC919Z removed from cradle during communications.	Replace MC919Z in cradle and retransmit.
	Incorrect cable configuration.	See the System Administrator.
	Communications software is not installed or configured properly.	Perform setup as described in the <i>Accessories</i> section of the <i>MC9190-G Integration Guide</i> . Ensure that Microsoft ActiveSync 4.5 or greater is installed on the host computer.

## Cable Adapter Module

**Table 6-7** Troubleshooting The Cable Adapter Module

Symptom	Possible Cause	Action
MC919Z battery is not charging.	MC919Z was removed from CAM or CAM was unplugged from AC power too soon.	Ensure CAM is receiving power. Ensure MC919Z is attached correctly. Confirm that the battery is charging. If a MC919Z battery is fully depleted, it can take up to four hours to fully recharge a battery (if the MC919Z is off and longer if the MC919Z is operating). For Windows Mobile 6.5 devices, view battery status by tapping <b>Start &gt; Settings &gt; System &gt; Power</b> .
	Battery is faulty.	Verify that other batteries charge properly. If so, replace the faulty battery.
	The MC919Z is not fully attached to the CAM.	Detach and re-attach the CAM to the MC919Z, ensuring it is firmly connected.
During data communications, no data was transmitted, or transmitted data was incomplete.	MC919Z detached from CAM during communications.	Re-attach MC919Z to CAM and retransmit.
	Incorrect cable configuration.	See the System Administrator.
	Communications software is not installed or configured properly.	Perform setup as described in the <i>Accessories</i> section of the <i>MC9190-G Integration Guide</i> .

## Magnetic Stripe Reader

**Table 6-8** *Troubleshooting the Magnetic Stripe Reader*

Symptom	Possible Cause	Action
MSR cannot read card.	MC919Z detached from MSR during card swipe.	Re-attach MC919Z to MSR and reswipe the card.
	Faulty magnetic stripe on card.	See the System Administrator.
	MSR application is not installed or configured properly.	Ensure the MSR application is installed on the MC919Z. Ensure the MSR application is configured correctly.
MC919Z battery is not charging.	MC919Z was removed from MSR or MSR was unplugged from AC power too soon.	Ensure MSR is receiving power. Ensure MC919Z is attached correctly. Confirm that the battery is charging. If a MC919Z battery is fully depleted, it can take up to four hours to fully recharge a battery (if the MC919Z is off and longer if the MC919Z is operating). For Windows Mobile 6.5 devices, view battery status by tapping <b>Start &gt; Settings &gt; System &gt; Power</b> .
	Battery is faulty.	Verify that other batteries charge properly. If so, replace the faulty battery.
	The MC919Z is not fully attached to the MSR.	Detach and re-attach the MSR to the MC919Z, ensuring it is firmly connected.
During data communications, no data was transmitted, or transmitted data was incomplete.	MC919Z detached from MSR during communications.	Reattach MC919Z to MSR and retransmit.
	Incorrect cable configuration.	See the System Administrator.
	Communications software is not installed or configured properly.	Perform setup as described in the <i>Accessories</i> section of the <i>MC9190-G Integration Guide</i> .

## Modem Module

**Table 6-9** *Troubleshooting the Modem Module*

Symptom	Possible Cause	Action
MC919Z is not communicating through the modem.	The modem cable is not fully connected.	Connect the modem cable securely to both the modem and the telephone jack.
	Modem is not securely connected to the MC919Z.	Reconnect the modem firmly to the MC919Z.
	Communication software is not installed or configured properly.	Set up the communication software as described in the <i>Accessories</i> section of the <i>MC9190-G Integration Guide</i> .
	Problem in the telephone lines.	Connect a conventional telephone and dial the remote modem to verify the telephone lines are functioning. If the remote modem does not answer the call and emit answering tones, contact the remote System Administrator.
	MC919Z's battery is low or discharged, which shuts off power to the modem.	Install a charged battery in the MC919Z, or use an external DC power adapter to recharge the battery.
ActiveSync fails.	A partnership was not established with the host computer.	Establish a partnership with the host computer (refer to the <i>MC9190-G Integration Guide</i> ).
	Host computer is not selected in the <b>ActiveSync</b> window on the MC919Z.	Select a host computer in the <b>ActiveSync</b> window, and perform setup (refer to the <i>MC9190-G Integration Guide</i> ).
	Modem RAS connection not allowed by host computer.	Select RAS connection in the host computer ( <b>File &gt; Connection Settings</b> window). Refer to the ReadMe files located in the Microsoft ActiveSync folder on the host computer.
	MC919Z or modem was disconnected from the telephone line while ActiveSync was in progress.	Disconnect the modem cable for 30 seconds to hang up the local telephone connection. Close any open windows on the MC919Z and any modem connections.
	Synchronization occurred, but the session is configured to close immediately after synchronization is complete.	Verify the setting of the <b>When manually synchronizing disconnect when complete</b> checkbox by tapping <b>Start &gt; ActiveSync &gt; Menu &gt; Options &gt; Schedule</b> tab.

**Table 6-9** *Troubleshooting the Modem Module (Continued)*

<b>Symptom</b>	<b>Possible Cause</b>	<b>Action</b>
Dial-out fails	Location setting is incorrect.	Verify Dialing Locations. Verify Dialing Patterns are correct for the current location. For example, enter 'G' in the <i>For local calls, dial:</i> field to dial directly, or '9,G' if the telephone system requires dialing '9' first to access an outside line.
	Incorrect server phone number.	Verify the connection phone number in the <b>Connecting</b> window.
	Pulse dialing not supported for country.	Use a connection within a tone-dialing system.
	The Connection Manager routes are incorrect.	Warm boot the MC919Z and confirm the connection settings.



# Appendix A Technical Specifications

## MC919Z Specifications

The following table summarizes the MC919Z's technical specifications.

**Table A-1** *Technical Specifications*

Item	Description
<b>Physical and Environmental Characteristics</b>	
Dimensions	10.83 in. L x 4.7 in. W x 7.6 in. H 27.50 cm L x 11.95 cm H x 19.3 cm H
Weight (includes battery, scanner and radio)	Lorax: 1077 g (38 oz.) SE4500 or SE960: 974 g (34.4 oz.)
Keyboard	28-key; 43-key; 53-key
Display	3.7" VGA color display with digitizer and backlight
Touch Screen	Integral resistive touch panel with 340 dpi resolution
Power	Removable, rechargeable 7.2 V Lithium Ion 2200 mAh battery pack, 15.8 watt hours
<b>Performance Characteristics</b>	
CPU	Marvell PXA320 processor at 806 MHz
Operating System	Windows Mobile 6.5
Memory	256 MB RAM/1 GB FLASH
Expansion	SD/MMC
Application Development	EMDK available through Zebra Support Central Web site

**Table A-1** *Technical Specifications (Continued)*

Item	Description
Data Capture Options	<p><b>SE960:</b> 1D standard range scan engine.</p> <p><b>SE1524-ER:</b> 1D extended range scan engine reads up to 45 ft./13.72 m away.</p> <p><b>SE4500-SR:</b> Omnidirectional 1D/2D imaging engine reads 1D and 2D symbols.</p> <p><b>SE4500-HD:</b> 1D/2D DPM imaging engine reads a wide variety of DPM marks on metal, plastic and glass surfaces, including: dot peening, laser etching, molding, stamping or casting.</p>
<b>User Environment</b>	
Operating Temperature	-4°F to 122°F (-20°C to 50°C)
Storage Temperature	-25°F to 160°F (-40°C to 70°C)
Battery Charging Temperature	32 °F to 104 °F (0 °C to +40 °C)
Humidity	5% to 95% non condensing
Drop Specification	Multiple drops to concrete: 6 ft./1.8 m across the operating temperature range; meets and exceeds MIL-STD 810G
Tumble	2,000 one-meter tumbles at room temperature (4,000 hits)
Environmental Sealing	IP64 (electronic enclosure, display and keypad)
ESD	<p>+/-15kVdc air discharge</p> <p>+/-8kVdc direct discharge</p> <p>+/-8kVdc indirect discharge</p>

**Table A-1** *Technical Specifications (Continued)*

Item	Description
<b>WLAN Wireless Data Communications</b>	
WLAN radio	802.11a/b/g. Note: 802.11a not available in Thailand.
Output Power	100mW U.S. and International
Data Rate	802.11a: up to 54Mb per second 802.11b: up to 11Mb per second 802.11g: up to 54Mb per second
Frequency Range	All country dependent: 802.11a - 5 GHz; 802.11b – 2.4 GHz; 802.11g – 2.4 GHz
Antenna	Integrated external
<b>WPAN Wireless Data Communications</b>	
Bluetooth	Bluetooth Version 2.1 with EDR
<b>Peripherals and Accessories</b>	
Cradles	Single-slot serial/USB, 4-slot Ethernet and 4-slot charge only
Printers	Supports extensive line of Zebra approved printers and cables
Charger	4-Slot universal battery charger, 4-slot battery charger
Other Accessories	Cable Adapter Module; snap-on Magnetic Stripe Reader; Modem module; full set of holsters; full set of cables

**Table A-2** *Data Capture Options*

Item	Description		
Laser Decode Capability	Code 39 Codabar Interleaved 2 of 5 MSI UPC/EAN supplementals Webcode RSS Expanded  Chinese 2 of 5	Code 128 Code 11 EAN-8 UPCA Coupon Code RSS-14	Code 93 Discrete 2 of 5 EAN-13 UPCE Trioptic 39 RSS Limited
Imaging Decode Capability	Code 39 Codabar Discrete 2 of 5 EAN-13 UPC/EAN supplementals Webcode Composite C Macro PDF-417 RSS Expanded Data Matrix US Planet Canadian 4-state  Chinese 2 of 5 microQR	Code 128 Code 11 MSI UPCA Coupon Code TLC39 Micro PDF-417 (Macro) Micro PDF-417 RSS Limited Maxi Code UK 4-state Japanese 4-state  USPS 4-state (US4CB)	Code 93 Interleaved 2 of 5 EAN-8 UPCE Trioptic 39 Composite AB PDF-417 QR Code RSS-14 US Postnet Australian 4-state Dutch Kix  Aztec

## Decode Zones

### SE960 Standard Range Laser Decode Zones

Figure A-1 shows the decode zone for the SE960 scan engine. The figures are typical values. Table A-3 lists the typical distances for selected bar code densities. The minimum element width (or “symbol density”) is the width in mils of the narrowest element (bar or space) in the symbol.

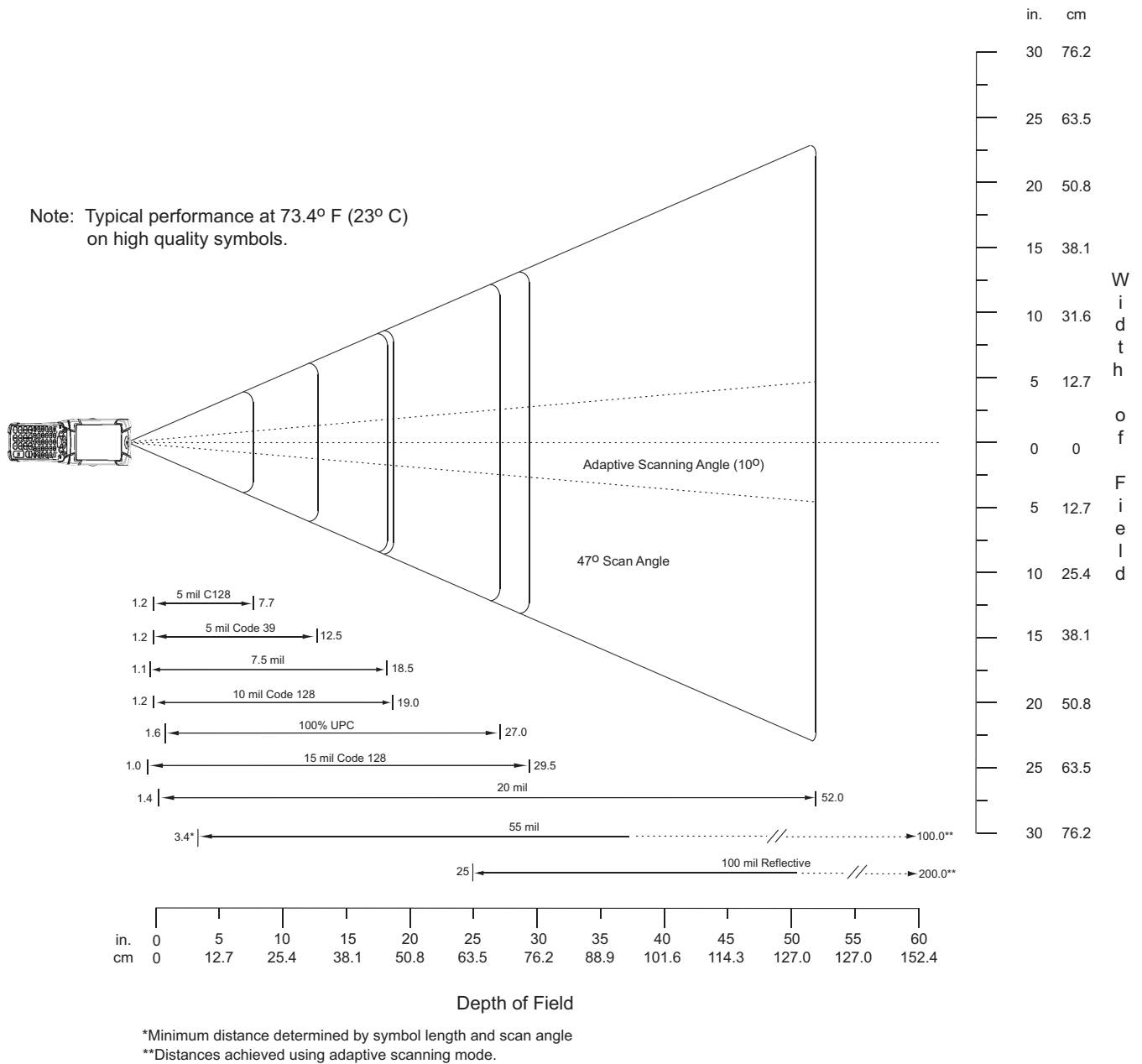

Figure A-1 SE960 Decode Zone

**Table A-3** SE960 Decode Distances

Symbol Density/ Bar Code Type/ W-N Ratio	Bar Code Content/ Contrast <sup>Note 1</sup>	Typical Working Ranges	
		Near	Far
5.0 mil Code 128	1234 80% MRD	1.2 in 3.05 cm	7.7 in 19.56 cm
5.0 mil Code 39; 2.5:1	ABCDEFGH 80% MRD	1.2 in 3.05 cm	12.5 in 31.75 cm
7.5 mil Code 39; 2.5:1	ABCDEF 80% MRD	1.1 in 2.79 cm	18.5 in 46.99 cm
10 mil Code 128	1234 80% MRD	1.2 in 3.05 cm Note 3	19.0 in 48.26 cm
13 mil 100% UPC	12345678905 80% MRD	1.6 in 4.06 cm	27.0 in 68.58 cm
15 mil Code 128	1234 80% MRD	1.0 in 2.54 cm Note 3	29.5 in 74.93 cm
20 mil Code 39; 2.2:1	123 80% MRD	1.4 in 3.56 cm Note 3	52.0 in 132.08 cm
55 mil Code 39; 2.2:1	CD 80% MRD	3.4 in 8.64 cm Note 3	100.0 in 254.00 cm
100 mil Code 39; 3.0:1 reflective	123456 80% MRD	2 ft 60.96cm Note 3	17 ft 518.16 cm

**Notes:**

1. Contrast measured as Mean Reflective Difference (MRD) at 650 nm.
2. Working range specifications at ambient temperature (23°C), photographic quality symbols. Pitch=10°, roll=0°, skew=0°, ambient light < 150 ft-candles using Symbol or equivalent decoder.
3. Dependent on width of bar code.
4. Distances measured from front edge of scan engine chassis.

### SE1524 Long Range Laser Decode Zones

Typical decode ranges are shown in *Figure A-2. Table A-4 on page A-8* lists the typical distances for the SE1524 for selected bar code densities. The minimum element width (or "symbol density") is the width in mils of the narrowest element (bar or space) in the symbol. The maximum usable length of a symbol at any given range is shown.

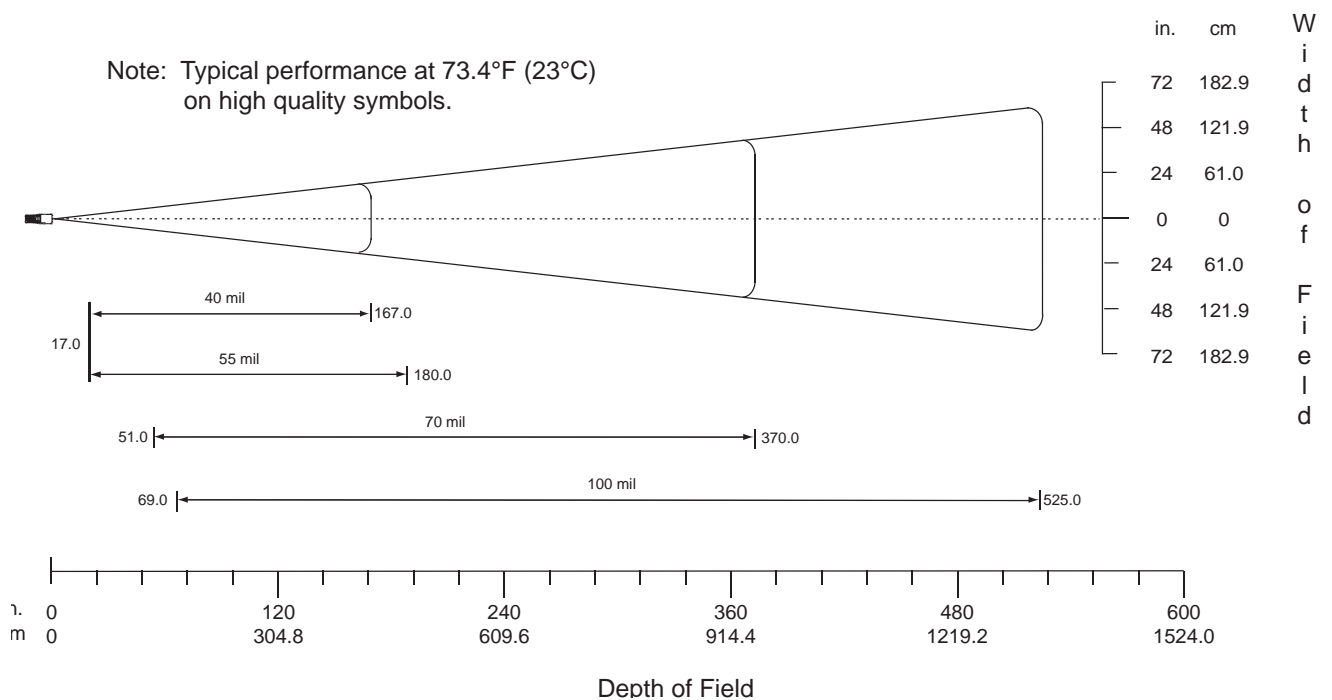
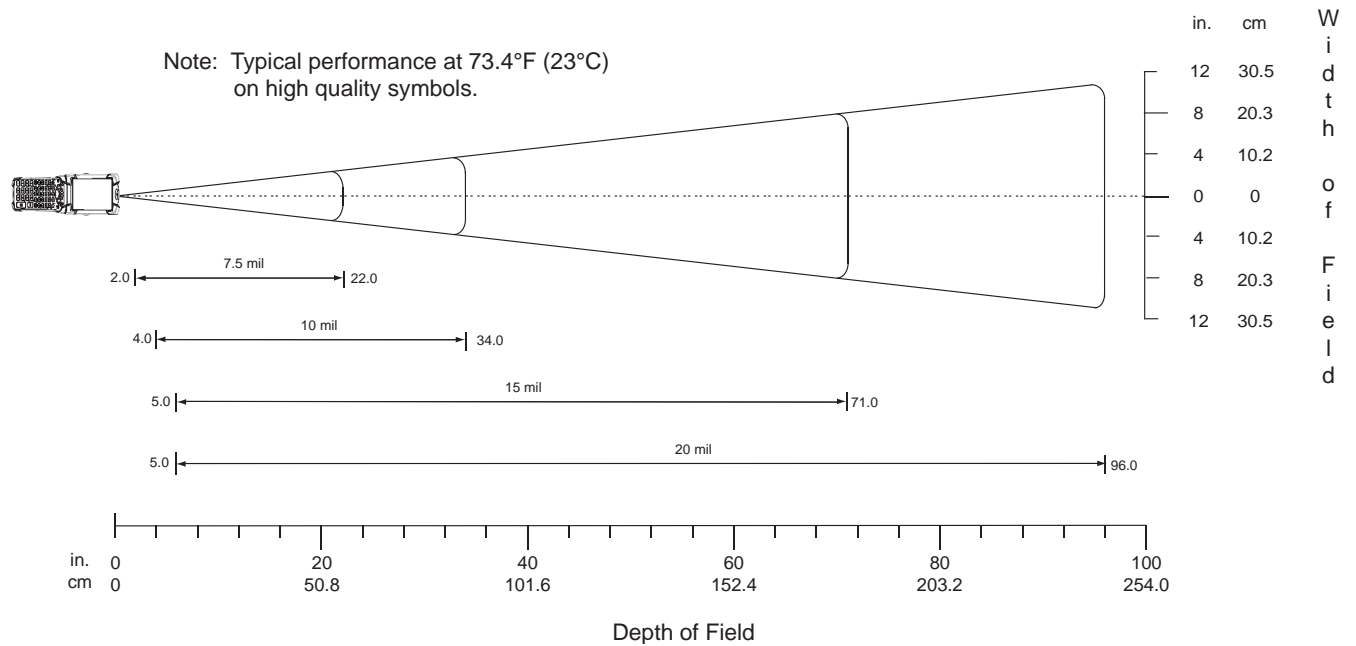

Figure A-2 SE1524 Decode Zones

**Table A-4** SE 1524 Decode Distances

Symbol Density/ p/n / Bar Code Type/ W-N Ratio	Bar Code Content/ Contrast <sup>Note 1</sup>	Typical Working Ranges	
		Near	Far
7.5 mil 64-17452-01 Code 39; 2.5:1	ABCDEF 80% MRD	2.0 in 5.08 cm	22.0 in 55.88 cm
10 mil 64-17454-01 Code 39; 2.5:1	ABCDE 80% MRD	4.0 in 10.16 cm	34.0 in 86.36 cm
15 mil 64-17417-01 Code 39; 2.5:1	ABCD 80% MRD	5.0 in 12.70 cm	71.0 in 180.34cm
20 mil 64-17456-01 Code 39; 2.2:1	123 80% MRD	5.0 in 12.70 cm	96.0 in 243.84 cm
55 mil 64-17458-01 Code 39; 2.2:1	CD 80% MRD	15.0 in 38.10 cm	180.0 in 457.20 cm
70 mil reflective 64-08780-01 Code 39; 3:1	123477 Reflective 80% MRD	Note 4	367.0 in 932.18 cm
100 mil reflective 64-16990-01 Code 39; 3:1	123456 Reflective 80% MRD	Note 4	542.0 in 1376.68 cm

**Notes:**

1. CONTRAST measured as Mean Reflective Difference (MRD) at 670 nm.
2. Near ranges are largely dependent upon the width of the bar code.
3. Working range specifications at temperature 23 °C.
4. Near range on reflective bar codes determined by degree of reflectivity and width of bar code.



## SE4500 Standard Range Imager Decode Zones

### SE4500-SR

Figure A-3 shows the decode zone for the SE4500-SR. Typical values appear. Table A-3 lists the typical distances for selected bar code densities. The minimum element width (or “symbol density”) is the width in mils of the narrowest element (bar or space) in the symbol.

Note: Typical performance at 73°F (23°C)  
on high quality symbols in normal room light.

Vcc = 3.3V

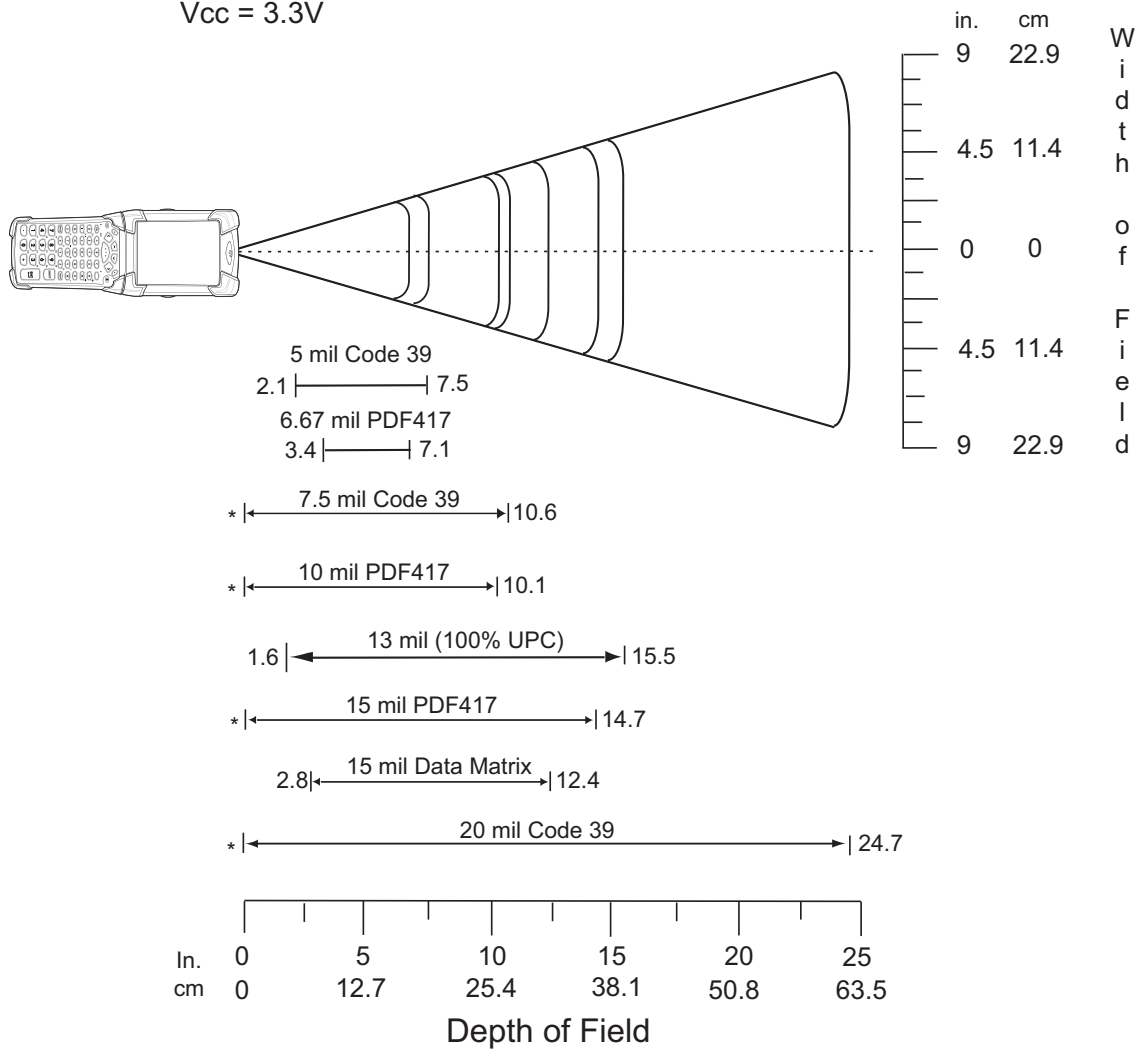

\* Minimum distance determined by symbol length and scan angle.

Figure A-3 SE4500-SR Decode Zone

**Table A-5** SE4500-SR Decode Distances

Symbol Density/ Bar Code Type	Bar Code Content/ Contrast <sup>Note 2</sup>	Typical Working Ranges	
		Near	Far
5.0 mil Code 39	ABCDEFGH 80% MRD	2.1 in 5.33 cm	7.5 in 19.05 cm
6.67 mil PDF417	4 Col, 20 Rows 80% MRD	3.4 in 8.64 cm	7.1 in 18.03 cm
7.5 mil Code 39	ABCDEF 80% MRD	Note 1	10.6 in 26.92 cm
10 mil PDF417	3 Col, 17 Rows 80% MRD	Note 1	10.1 in 25.65 cm
13 mil UPC-A	012345678905 80% MRD	1.6 in 5.08 cm	15.5 in 39.37 cm
15 mil PDF417	80% MRD	Note 1	14.7 in 37.34 cm
15 mil Data Matrix	18 x 18 Modules 80% MRD	2.8 in 7.11 cm	12.4 in 31.50 cm
20 mil Code 39	123 80% MRD	Note 1	24.7 in 62.74 cm

Notes:

1. Near distances are field-of-view (FOV) limited.
2. Contrast is measured as Mean Reflective Difference (MRD) at 670 nm.
3. Working range specifications at temperature = 23°C, pitch=18°, roll=0°, skew=0°, photographic quality, ambient light ~30 ft-c, humidity 45-70% RH.
4. Distances measured from front edge of scan engine chassis.

**SE4500-HD**

Figure A-4 shows the decode zone for the SE4500-HD. Typical values appear. Table A-6 lists the typical distances for selected bar code densities. The minimum element width (or “symbol density”) is the width in mils of the narrowest element (bar or space) in the symbol.

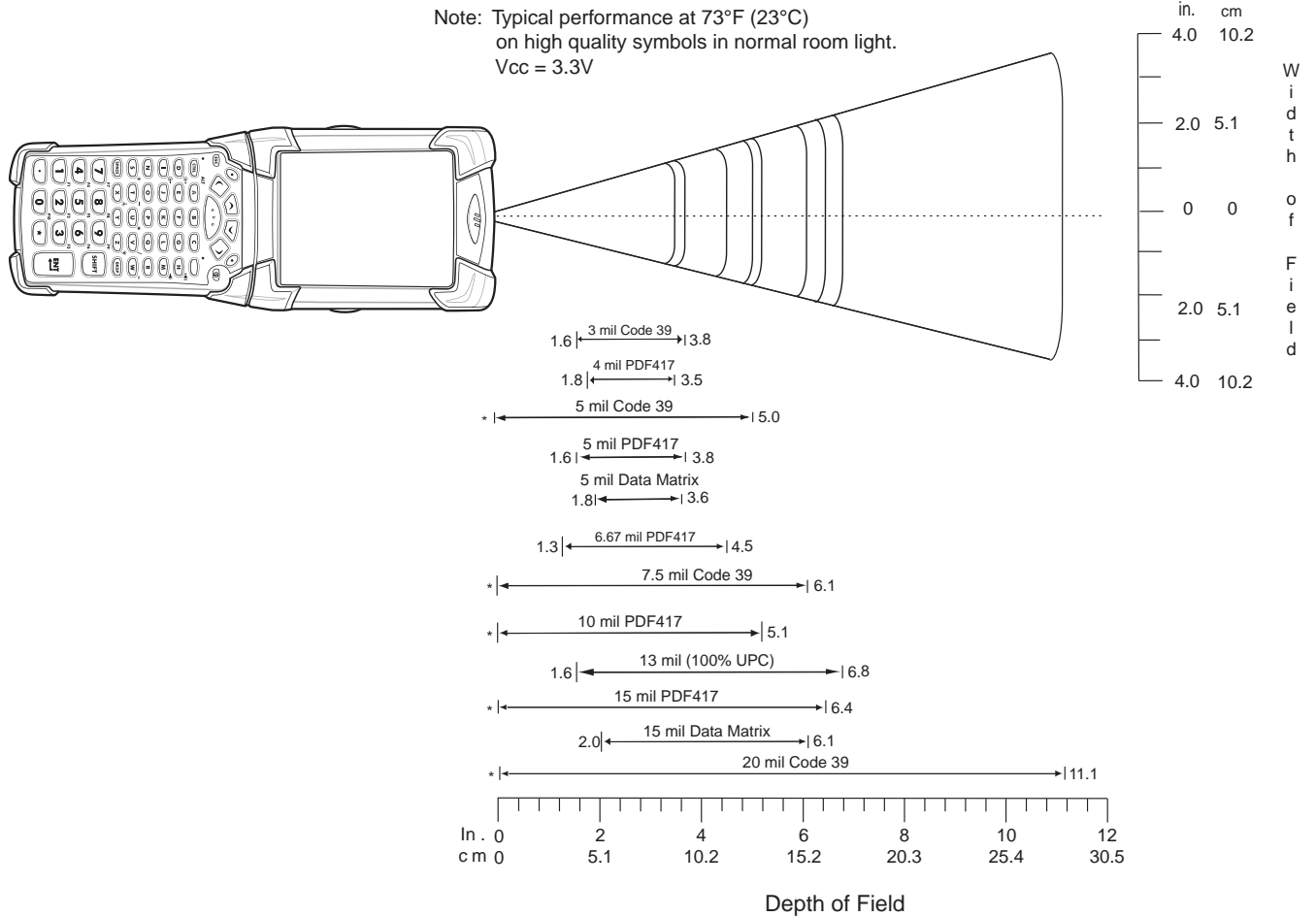

**Figure A-4** SE4500-HD Decode Zone

**Table A-6** SE4500-HD Decode Distances

Symbol Density/ Bar Code Type	Bar Code Content/ Contrast <sup>Note 2</sup>	Typical Working Ranges	
		Near	Far
3.0 mil Code 39	80% MRD	1.6 in 4.06 cm	3.8 in 9.65 cm
4.0 mil PDF417	80% MRD	1.8 in 4.57 cm	3.5 in 8.89 cm
5.0 mil Code 39	ABCDEFGH 80% MRD	Note 1	5.0 in 12.70 cm
5.0 mil PDF417	80% MRD	1.6 in 4.06 cm	3.8 in 9.65 cm
5 mil Data Matrix	18 x 18 Modules 80% MRD	1.8 in 4.57 cm	3.6 in 9.15 cm
6.67 mil PDF417	4 Col, 20 Rows 80% MRD	1.3 in 3.30 cm	4.5 in 11.43 cm
7.5 mil Code 39	ABCDEF 80% MRD	Note 1	6.1 in 15.49 cm
10 mil PDF417	3 Col, 17 Rows 80% MRD	Note 1	5.1 in 12.95 cm
13 mil UPC-A	012345678905 80% MRD	1.6 in 4.06 cm	6.8 in 17.27 cm
15 mil PDF417	80% MRD	Note 1	6.4 in 16.26 cm
15 mil Data Matrix	18 x 18 Modules 80% MRD	2.0 in 5.08 cm	6.1 in 15.49 cm
20.0 mil Code 39	123 80% MRD	Note 1	11.1 in 28.19 cm

**Notes:**

1. Near distances are FOV limited.
2. Contrast is measured as Mean Reflective Difference (MRD) at 670 nm.
3. Working range specifications at temperature = 23°C, pitch=18°, roll=0°, skew=0°, photographic quality, ambient light ~30 ft-c, humidity 45-70% RH.
4. Distances measured from front edge of scan engine chassis.

## Mobile Computer Pin-Outs

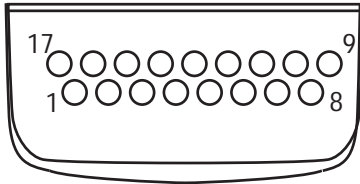

Figure A-5 Pin Locations m

Table A-7 Pin-Outs

PIN Number	Signal Name	Function
1	USB_GND	USB
2	USB_D_PLUS	USB
3	TXD	RS232C
4	RXD	RS232C
5	DCD	RS232C
6	RTS	RS232C
7	DSR	RS232C
8	GND	Ground, 2.5A max.
9	RI	RS232C
10	CRADLE_DET	Grounded by cradle when in cradle
11	DTR	RS232C
12	Not connected	Not connected
13	POWER_IN	12V, 2.5A max
14	CTS	RS232C
15	USB_5V_DET	USB
16	USB_D_MINUS	USB
17	EXT_PWR_OUT	3.3V @500mA

## Accessory Specifications

### Single Slot Serial/USB Cradle

**Table A-8** *Single Slot Serial/USB Cradle Technical Specifications*

Feature	Description
Dimensions	Height: 13.02 cm (5.13 in.) Width: 15.24 cm (6.0 in.) Depth: 15.24 cm (6.0 in.)
Input Power	12 VDC
Interface	Serial and USB
Operating Temperature	-25°C to 50°C (-13°F to 122°F)
Storage Temperature	-40°C to 70°C (-40°F to 158°F)
Charging Temperature	0°C to 40°C (32°F to 104°F)
Humidity	5% to 95% non-condensing
Drop	76.2 cm (30.0 in.) drops to vinyl tiled concrete at room temperature
Electrostatic Discharge (ESD)	+/- 15 kV air +/- 8 kV contact

### Four Slot Ethernet Cradle

**Table A-9** *Four Slot Ethernet Cradle Technical Specifications*

Feature	Description
Dimensions	Height: 10.16 cm (4.0 in.) Width: 48.77 cm (19.00 in.) Depth: 15.24 cm (6.0 in.)
Input Power	12 VDC
Interface	Ethernet
Operating Temperature	-25°C to 50°C (-13°F to 122°F)
Storage Temperature	-40°C to 70°C (-40°F to 158°F)
Charging Temperature	0°C to 40°C (32°F to 104°F)

**Table A-9** *Four Slot Ethernet Cradle Technical Specifications (Continued)*

Feature	Description
Humidity	5% to 95% non-condensing
Drop	76.2 cm (30.0 in.) drops to vinyl tiled concrete at room temperature
Electrostatic Discharge (ESD)	+/- 15 kV air +/- 8 kV contact

### Four Slot Charge Only Cradle

**Table A-10** *Four Slot Charge Only Cradle Technical Specifications*

Feature	Description
Dimensions	Height: 10.16 cm (4.0 in.) Width: 48.77 cm (19.00 in.) Depth: 15.24 cm (6.0 in.)
Input Power	12 VDC
Operating Temperature	-25°C to 50°C (-13°F to 122°F)
Storage Temperature	-40°C to 70°C (-40°F to 158°F)
Charging Temperature	0°C to 40°C (32°F to 104°F)
Humidity	5% to 95% non-condensing
Drop	76.2 cm (30.0 in.) drops to vinyl tiled concrete at room temperature
Electrostatic Discharge (ESD)	+/- 15 kV air +/- 8 kV contact

### Four Slot Battery Charger

**Table A-11** *Four Slot Battery Charger Technical Specifications*

Feature	Description
Dimensions	Height: 10.16 cm (4.0 in.) Width: 15.24 cm (6.0 in.) Depth: 15.24 cm (6.0 in.)
Input Power	12 VDC
Operating Temperature	0°C to 45°C (32°F to 113°F)
Storage Temperature	-40°C to 70°C (-40°F to 158°F)
Charging Temperature	0°C to 40°C (32°F to 104°F)

**Table A-11** *Four Slot Battery Charger Technical Specifications (Continued)*

Feature	Description
Humidity	5% to 95% non-condensing
Drop	76.2 cm (30.0 in.) drops to vinyl tiled concrete at room temperature
Electrostatic Discharge (ESD)	+/- 15 kV air +/- 8 kV contact

## Magnetic Stripe Reader

**Figure A-6** *Magnetic Stripe Reader (MSR) Technical Specifications (Continued)*

Feature	Description
Interface	Serial with baud rate up to 19,200
Format	ANSI, ISO, AAMVA, CA DMV, user-configurable generic format
Swipe Speed	5 to 50 in. (127 to 1270 mm) /sec, bi-directional
Decoders	Generic, Raw Data
Mode	Buffered, unbuffered
Track Reading Capabilities	Tracks 1 and 3: 210 bpi Track 2: 75 and 210 bpi, autodetect
Operating Temperature	-25°C to 50°C (-13°F to 122°F)
Storage Temperature	-40°C to 70°C (-40°F to 158°F)
Humidity	5% to 95% non-condensing
Drop	1.22 m (4 ft.) drops to concrete
Electrostatic Discharge (ESD)	+/- 15 kV air +/- 8 kV contact



## Accessory CAM and MSR Pin-Outs

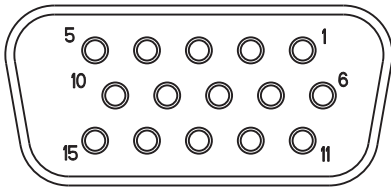

**Figure A-7** CAM and MSR Serial Connector

**Table A-12** CAM and MSR Serial Connector Pin-outs

Pin	Signal
1	USB_5V_DET
2	USB_D_MINUS
3	USB_D_PLUS
4	GND
5	GND
6	PWR_EXT_OUT
7	CRADLE_DET*
8	DSR
9	DCD
10	TXD
11	CTS
12	DTR
13	RI
14	RTS
15	RXD



# Appendix B RFID APIs

RFID APIs are available in C, .NET, and Java. For information on supported RFID APIs, refer to the *Enterprise Mobility Developer Kit* (EMDK), available at <http://www.zebra.com/support>

For C, refer to the EMDK for C v2.1 or later. For .Net, refer to the EMDK for .NET v2.2 or later.



# Index

## A

activesync ..... 2-1  
antenna ..... 1-2, 1-3  
APIs ..... B-1

## B

battery charging temperature ..... A-2  
bullets ..... x

## C

configuration ..... ix  
configuring MobileRFID ..... 3-7  
    region ..... 3-4  
connection  
    sample application ..... 4-3  
conventions  
    notational ..... x  
CPU ..... A-1

## D

DCP for MC9090w ..... xi  
decode distances ..... A-6, A-8  
    HD focus ..... A-12  
    SR focus ..... A-10  
decode zone ..... A-5  
decode zones ..... A-7, A-9  
    DL focus ..... A-10  
    HD focus ..... A-11  
demo ..... 4-1  
    connection ..... 4-3  
    launching ..... 4-2  
Device Configuration Package for MC9090w ..... xi  
dimensions ..... A-1

display ..... A-1  
drop specification ..... A-2

## E

EMDK for eVC4 ..... xi  
Enterprise Mobility Developer Kit for eVC4 ..... xi

## F

firmware update ..... 2-2

## H

HD focus decode distances ..... A-12  
humidity ..... A-2

## I

icons  
    MobileRFID ..... 3-2  
image update ..... 2-1  
    activesync ..... 2-1  
    update loader ..... 2-1  
information, service ..... xi

## K

keyboard ..... A-1

## L

locating tags ..... 5-1

## M

memory ..... A-1

MobileRFID .....	3-1
client mode .....	3-7
configuring .....	3-7
configuring region .....	3-4
icons .....	3-2
menu .....	3-3
server mode .....	3-7
starting .....	3-9
stopping .....	3-9
version information .....	3-8

## O

operating system .....	A-1
operating temperature .....	A-2

## P

pin-outs	
accessory .....	A-17
mobile computer .....	A-13

## R

radio .....	1-2
region	
configuring .....	3-4
RFID APIs .....	B-1
RFID components .....	1-2
antennas .....	1-2
radio .....	1-2
tags .....	1-2
RFID firmware update .....	2-2
RFID overview .....	1-1

## S

sample application .....	4-1
connection .....	4-3
launching .....	4-2
SR focus decode distances .....	A-10
starting RFID .....	3-9
stopping RFID .....	3-9
storage temperature .....	A-2

## T

tags .....	1-2
locating .....	5-1
troubleshooting .....	6-1

## U

updating device .....	2-1
-----------------------	-----

activesync .....	2-1
firmware .....	2-2
RFID firmware .....	2-2
update loader .....	2-1

## W

weight .....	A-1
--------------	-----





**Zebra Technologies Corporation**  
Lincolnshire, IL U.S.A.  
<http://www.zebra.com>

**Zebra and the Zebra head graphic are registered trademarks of ZIH Corp. The Symbol logo is a registered trademark of Symbol Technologies, Inc., a Zebra Technologies company.**

**© 2015 Symbol Technologies, Inc.**



**72E-157455-02 Revision A - March 2015**